

Aspire 8930Q Series Service Guide

Service guide files and updates are available on the ACER/CSD web; for more information, please refer to <http://csd.acer.com.tw>

PRINTED IN TAIWAN

Revision History

Please refer to the table below for the updates made on Aspire 8930Q service guide.

Date	Chapter	Updates

Copyright

Copyright © 2008 by Acer Incorporated. All rights reserved. No part of this publication may be reproduced, transmitted, transcribed, stored in a retrieval system, or translated into any language or computer language, in any form or by any means, electronic, mechanical, magnetic, optical, chemical, manual or otherwise, without the prior written permission of Acer Incorporated.

Disclaimer

The information in this guide is subject to change without notice.

Acer Incorporated makes no representations or warranties, either expressed or implied, with respect to the contents hereof and specifically disclaims any warranties of merchantability or fitness for any particular purpose. Any Acer Incorporated software described in this manual is sold or licensed "as is". Should the programs prove defective following their purchase, the buyer (and not Acer Incorporated, its distributor, or its dealer) assumes the entire cost of all necessary servicing, repair, and any incidental or consequential damages resulting from any defect in the software.

Acer is a registered trademark of Acer Corporation.

Intel is a registered trademark of Intel Corporation.

Pentium and Pentium II/III are trademarks of Intel Corporation.

Other brand and product names are trademarks and/or registered trademarks of their respective holders.

Conventions

The following conventions are used in this manual:

SCREEN MESSAGES	Denotes actual messages that appear on screen.
NOTE	Gives bits and pieces of additional information related to the current topic.
WARNING	Alerts you to any damage that might result from doing or not doing specific actions.
CAUTION	Gives precautionary measures to avoid possible hardware or software problems.
IMPORTANT	Reminds you to do specific actions relevant to the accomplishment of procedures.

Preface

Before using this information and the product it supports, please read the following general information.

1. This Service Guide provides you with all technical information relating to the BASIC CONFIGURATION decided for Acer's "global" product offering. To better fit local market requirements and enhance product competitiveness, your regional office MAY have decided to extend the functionality of a machine (e.g. add-on card, modem, or extra memory capability). These LOCALIZED FEATURES will NOT be covered in this generic service guide. In such cases, please contact your regional offices or the responsible personnel/channel to provide you with further technical details.
2. Please note WHEN ORDERING FRU PARTS, that you should check the most up-to-date information available on your regional web or channel. If, for whatever reason, a part number change is made, it will not be noted in the printed Service Guide. For ACER-AUTHORIZED SERVICE PROVIDERS, your Acer office may have a DIFFERENT part number code to those given in the FRU list of this printed Service Guide. You MUST use the list provided by your regional Acer office to order FRU parts for repair and service of customer machines.

System Specifications

Features

Below is a brief summary of the computer's many features:

Operating system

- ❑ Windows Vista™

NOTE: Windows® Vista™ Capable PCs come with Windows® XP installed, and can be upgraded to Windows® Vista™. For more information on Windows® Vista™ and how to upgrade, go to: Microsoft.com/windowsvista.

Platform and memory

- ❑ Intel® Core™4 Quad mobile processor Mobile Intel® PM975 Express Chipset
- ❑ Mobile Intel® PM975 Express Chipset
- ❑ Intel® Wireless WiFi Link Wi-Fi CERTIFIED® network connection, or Intel® PRO/Wireless Wi-Fi CERTIFIED® network connection

System memory

- ❑ Dual-Channel DDR3 SDRAM support
- ❑ Up to 2 GB of DDR3 800/1066 MHz memory, upgradeable to 4 GB using two soDIMM modules

Display and graphics

- ❑ 18.4" WUXGA
- ❑ NVIDIA® GeForce® 9650M GS with up to 1280 MB of TurboCache™ or NVIDIA® GeForce® 8600M GT with up to 1280 MB of TurboCache™

TV-tuner

- ❑ Digital TV-tuner supporting DVB-T

Audio

- ❑ Dolby® -certified surround sound system with five built-in stereo speakers and one subwoofer supporting lowfrequency effects
- ❑ S/PDIF (Sony/Philips Digital Interface) support for digital speakers
- ❑ Built-in stereo microphones

Storage subsystem

- ❑ 2.5" hard disk drive
- ❑ Optical drive options:
 - Blu-ray Disc™ (BD) drive
 - DVD-Super Multi double-layer drive
- ❑ 6-in-1 card reader

Input devices

- ❑ 105-/106-key keyboard
- ❑ Touchpad pointing device
- ❑ Acer CineDash media console capacitive human interface device

Communication

- ❑ Acer Video Conference, featuring:
 - Integrated Acer Crystal Eye webcam
 - Acer PureZone technology
 - Optional Acer Xpress VoIP phone
- ❑ WLAN:
 - Intel® Wireless WiFi Link network connection or Intel® PRO/Wireless network connection

I/O Ports

- ❑ ExpressCard™/54 slot
- ❑ 6-in-1 card reader (SD™, MMC, MMCplus™, MS, MS PRO, xD)
- ❑ USB 2.0 ports
- ❑ HDMI™ port with HDCP support
- ❑ Consumer infrared (CIR) port
- ❑ External display (VGA) port
- ❑ Headphone/speaker/line-out jack with S/PDIF support
- ❑ Microphone-in jack
- ❑ Line-in jack
- ❑ Ethernet (RJ-45) port
- ❑ Modem (RJ-11) port
- ❑ DC-in jack for AC adapter

Environment

- ❑ Temperature:
 - operating: 5°C to 35°C
 - Non-operating: -20°C to 65°C
- ❑ Humidity (non-condensing):
 - operating: 20%~80%
 - Non-operating: 20%~80%

System Block Diagram

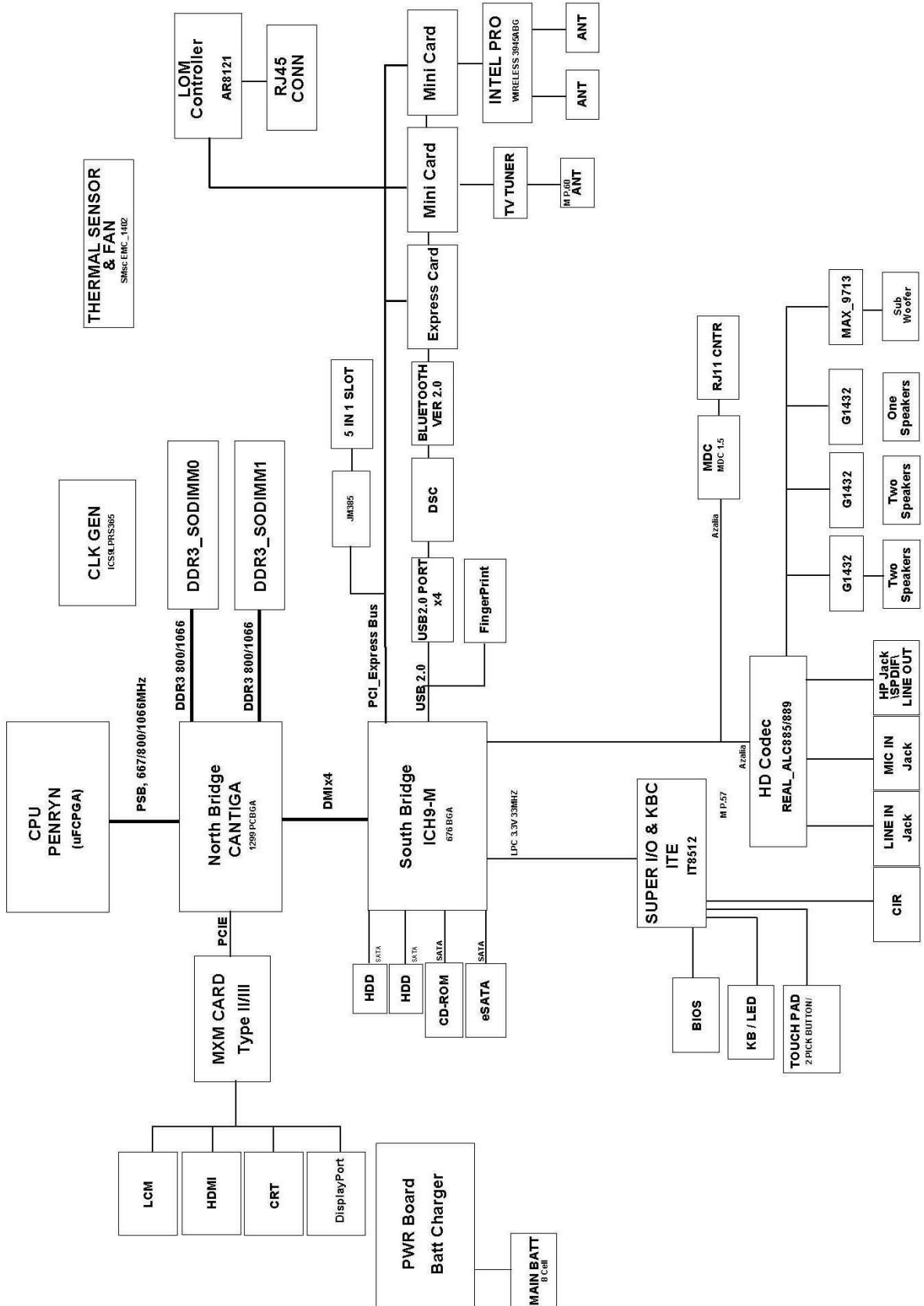

Board Layout

Top View

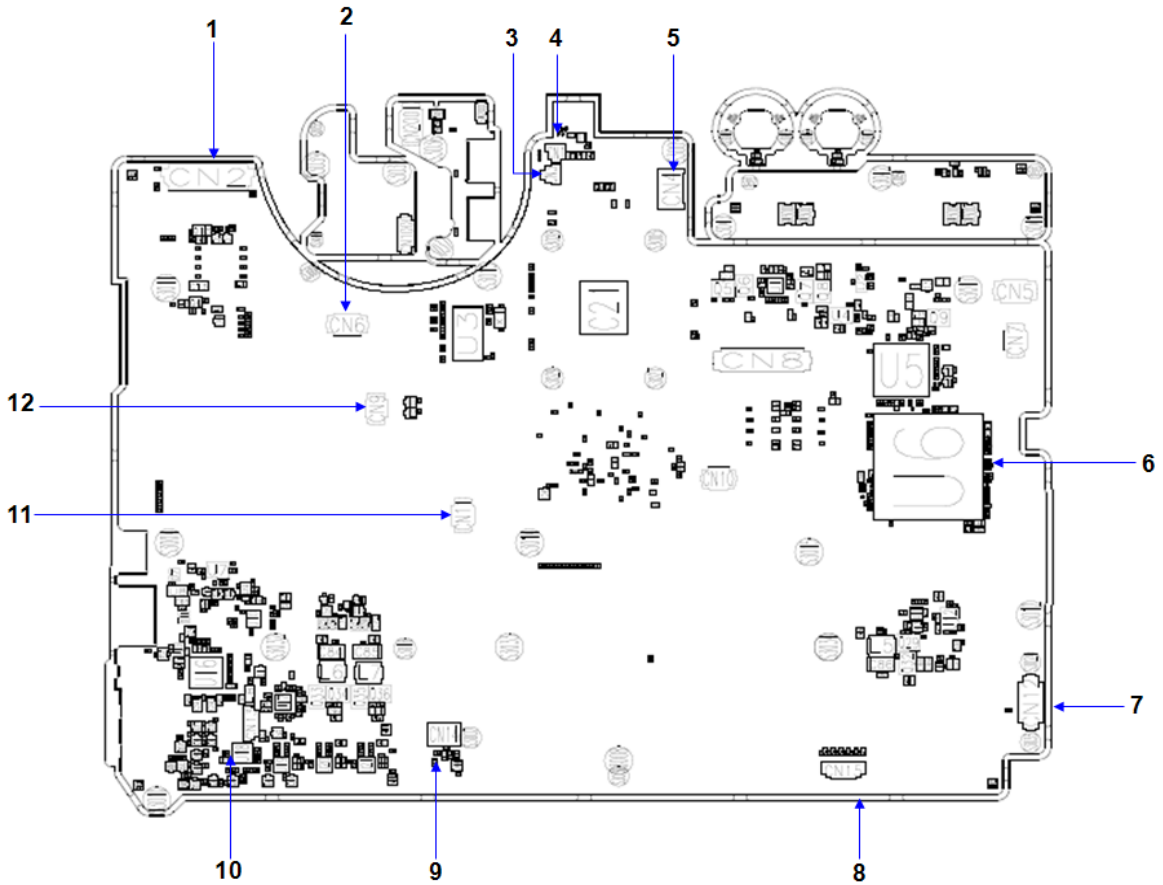

Aspire8930Q M/B layout and connector location TOP view		
No.	Name	Description
1	CN2	LCM Cable CNTR
2	CN6	Power Board FFC CNTR
3	CN3	LED Board Cable CNTR
4	CN1	LED Board Cable CNTR
5	CN4	Power Cable CNTR
6	U6	South Bridge
7	CN12	I/O Board CNTR
8	CN15	Speaker Cable CNTR
9	CN14	MDC CNTR
10	CN13	BT Cable CNTR
11	CN11	Touch Pad FFC CNTR
12	CN9	Media consle Board CNTR

Bottom View

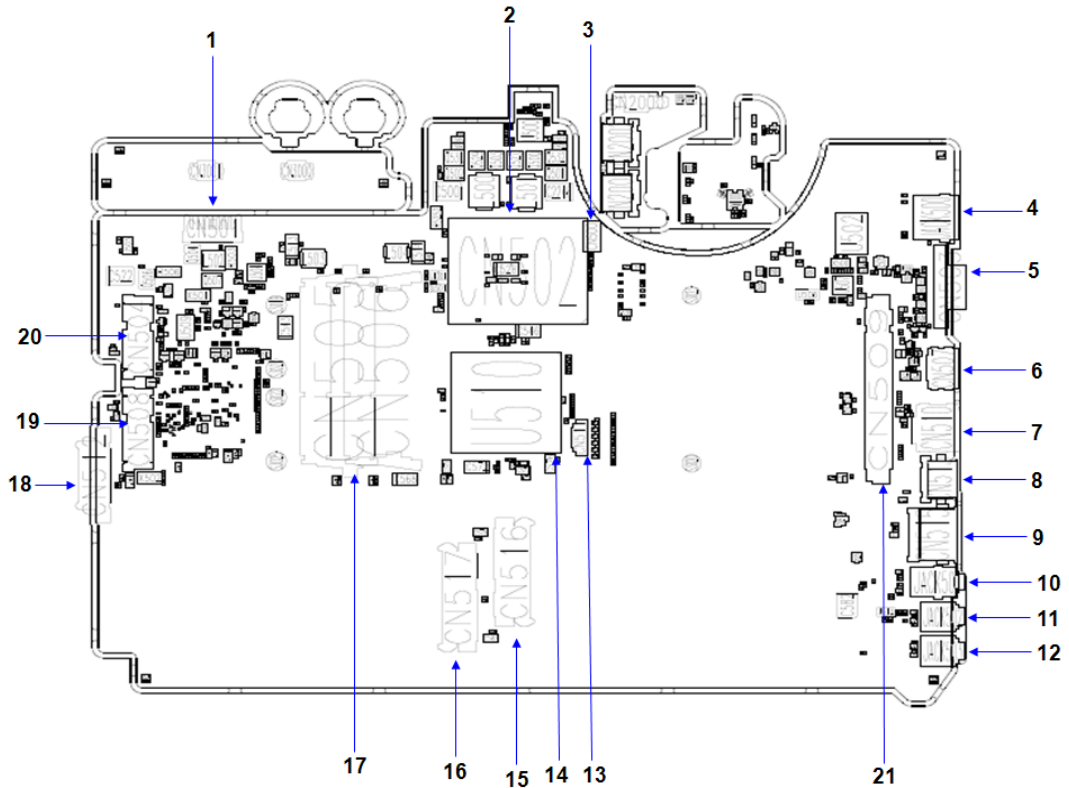





Bottom view		
No.	Name	Description
1	CN501	Battery CNTR
2	CN502	CPU Socket
3	CN500	FAN Cable CNTR
4	Jack500	RJ45
5	CN503	VGA Port
6	CN507	HDMI Port
7	CN510	HDMI Port
8	CN513	USB Port
9	CN515	USB Port
10	Jack501	SPDIF
11	Jack502	MIC jack
12	Jack503	Line in jack
13	CN511	Speaker Cable CNTR
14	U510	North Bridge
15	CN516	HDD Socket
16	CN517	HDD Socket
17	CN505/506	DIMM Socket
18	CN512	ODD CNTR
19	CN508	PCI-E Socket
20	CN504	PCI-E Socket
21	CN509	VGA Card Socket

Your Acer Notebook tour

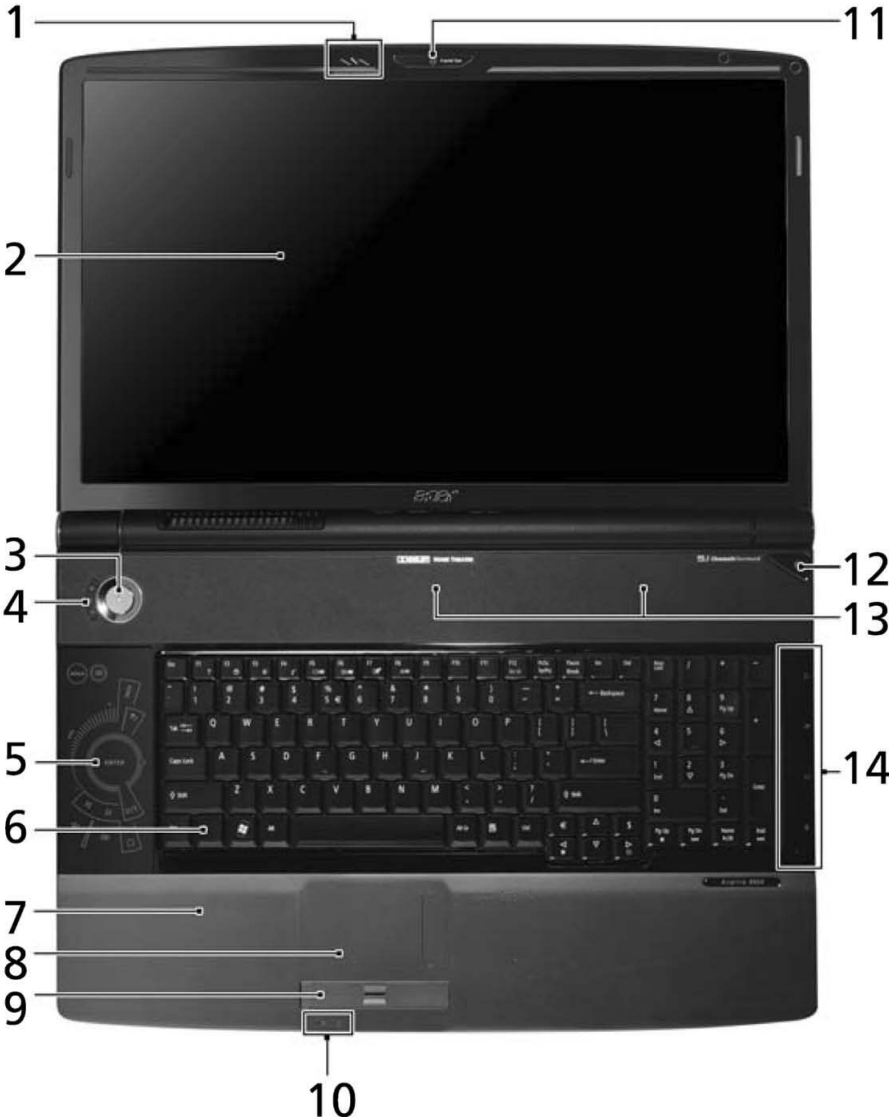
After knowing your computer features, let us show you around your new Aspire computer.



Front View

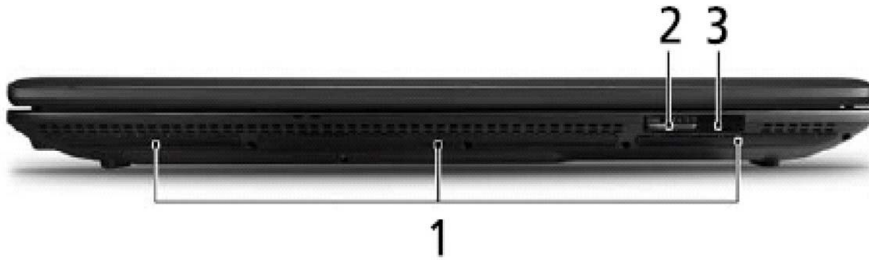

No.	Icon	Item	Description
1		Acer PureZone	Two internal stereo microphones for sound recording.
2		Display screen	Also called Liquid-Crystal Display (LCD), displays computer output.
3		Power button	Turns the computer on and off.
4		Status indicators	Light-Emitting Diodes (LEDs) that light up to show the status of the computer's functions and components.
5		CineDash media console	The CineDash media console is a touch-sensitive entertainment interface.
6		Keyboard	For entering data into your computer.
7		Palmrest	Comfortable support area for your hands when you use the computer.
8		Touchpad	Touch-sensitive pointing device which functions like a computer mouse.
9		Click buttons (left, center* and right)	The left and right buttons function like the left and right mouse buttons. *The center button serves as Acer BioProtect fingerprint reader supporting Acer FingerNav 4-way control function. (for selected models)
10		Status indicators	Light-Emitting Diodes (LEDs) that light up to show the status of the computer's functions and components.
11		Acer Crystal Eye	Web camera for video communication. (for selected models)
12		Empowering key	Launch Acer Empowering Technology.
13		Speakers	Left and right speakers deliver stereo audio output.
14		Easy-launch button	Buttons for launching frequently used program.

Closed Front View



No.	Icon	Item	Description
1		Speakers	Left and right speakers deliver stereo audio output.
2		6-in-1 card reader	Accepts Secure Digital (SD), MultiMediaCard (MMC), MultiMediaCard Plus (MMCplus), Memory Stick (MS), Memory Stick Pro (MS PRO), xD-Picture Card (xD).
3		CIR receiver	Receives signals from a remote control.







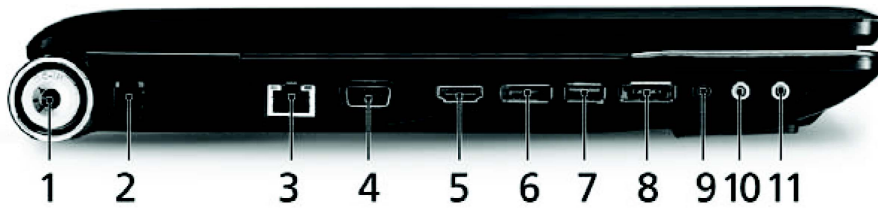

Rear view



No.	Icon	Item	Description
1		Tuba	The dedicated Tuba CineBass subwoofer pumps out earthshaking movie-house audio.
2		Ventilation slots	Enable the computer to stay cool, even after prolonged use.





Left View



No.	Icon	Item	Description
1		DC-in jack	Connects to an AC adapter.
2		Modem (RJ-11) port	Connects to a phone line.
3		Ethernet (RJ-45) port	Connects to an Ethernet 10/100-based network.
4		External display (VGA) port	Connects to a display device (e.g., external monitor, LCD projector).
5	HDMI	HDMI port	Supports high definition digital video connections.
6	DISPLAY	DISPLAY port	Supports high definition digital video connections.
7		2 USB 2.0 ports	Connect to USB 2.0 devices (e.g., USB mouse, USB camera).
8		USB 2.0 / eSATA port	Connects to USB 2.0 or eSATA devices (only for certain models). Note: If you plug an eSATA device you will have three USB ports available in the mean time.
9		Headphones/ speaker/line-out jack with S/PDIF support	Connects to audio line-out devices (e.g., speakers, headphones).
10		Microphone-in jack	Accepts input from external microphones.
11		Line-in jack	Accepts audio line-in devices (e.g., audio CD player, stereo walkman).





Right View

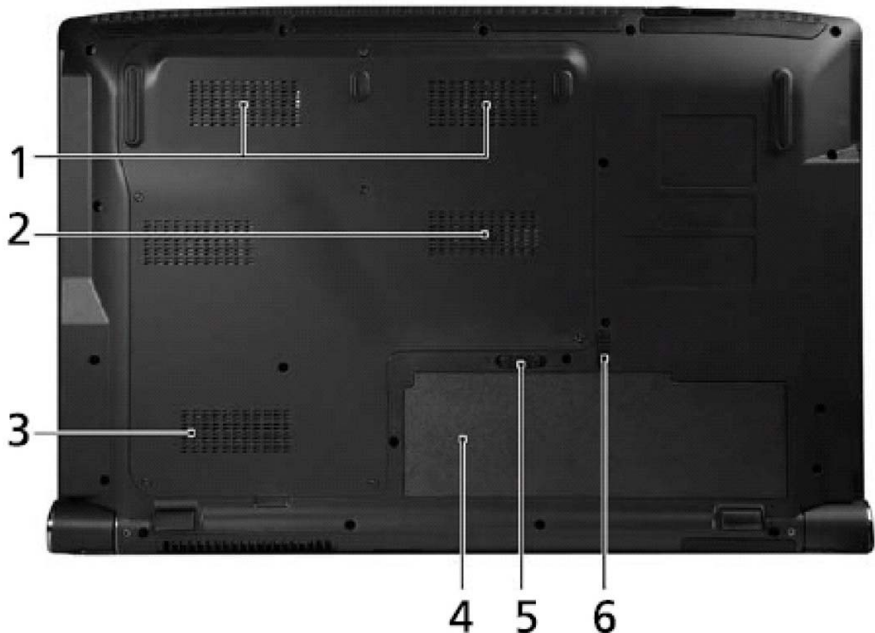

No.	Icon	Item	Description
1		ExpressCard/54 slot	Accepts one ExpressCard/54 module.
2		Optical drive	Internal optical drive; accepts CDs or DVDs.
3		Optical disk access indicator	Lights up when the optical drive is active.
4		Optical drive eject button	Ejects the optical disk from the drive.
5		Emergency eject hole	Ejects the optical drive tray when the computer is turned off.
6		2 USB 2.0 ports	Connect to USB 2.0 devices (e.g., USB mouse, USB camera).
7		TV-in port	Accepts input signals from analog/digital TV-tuner devices (for selected models).
8		Kensington lock slot	Connects to a Kensington-compatible computer security lock.

Base view



No.	Icon	Item	Description
1		Hard disk bay	Houses the computer's hard disk (secured with screws).
2		Memory compartment	Houses the computer's main memory.
3		Ventilation slots and cooling fan	Enable the computer to stay cool, even after prolonged use. Note: Do not cover or obstruct the opening of the fan.
4		Battery bay	Houses the computer's battery pack.
5		Battery release latch	Releases the battery for removal.
6		Battery lock	Locks the battery in position.

Acer CineDash media console

Acer CineDash media console is a touch-sensitive entertainment interface that features an ultra-smooth surface, inviting to the touch. Total media control - including instant access to Acer Arcade™ Deluxe - provides a new, exciting way to launch and control entertainment. Functions are activated by simply tapping the function with your finger, while you can adjust volume by sliding your finger around the volume meter.

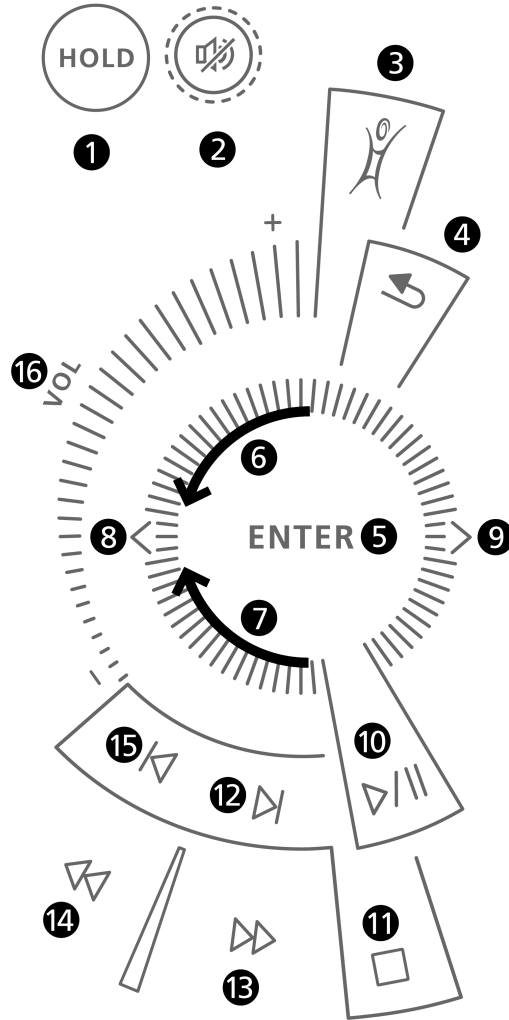

No.	Item	Album	Video	Play Movie	Music
1	Hold	N/A	N/A	N/A	N/A
2	Mute	Mute/unmute audio			
3	Arcade	Return to Main page			
4	Back	Go back one step			
5	Enter	1. Function button: Perform selected function			
		2. View image fullscreen	2. Watch video fullscreen	2. Perform movie menu function	2. Play highlighted track
6	Slide counter clockwise from top	Select previous item		Select previous menu item	Select previous item
7	Slide clockwise from bottom	Select next item		Select next menu item	Select next item
8	Left arrow	Select previous item		Select previous menu item	Select previous item
9	Right arrow	Select next item		Select next menu item	Select next item
10	Play/ Pause	Play/pause slideshow	Play/pause video	Play/pause movie	Play/pause music
11	Stop	1. Stop slideshow 2. Stop playing music	1. Stop playing video fullscreen 2. Stop playing music	Stop movie	Stop playing music
12	Next	Jump to next image in slideshow	Jump to next video and play fullscreen	Jump to next chapter/title and play fullscreen	Jump to and play next track
13	Forward	N/A	Fast forward* 1.2x, 1.4x, 2x, 4x, 8x, 16x, 32x		Jump forward 5 sec and keep playing
14	Rewind	N/A	Rewind* 1x, 2x, 4x, 8x, 16x, 32x		Jump back 5 sec and keep playing
15	Previous	Jump to previous image in slideshow	ump to previous video and play fullscreen	Jump to previous chapter/title and play fullscreen	Jump to and play previous track
16	Vol Up/ down	Increase/decrease volume			





NOTE: !* depends on file format

Indicators

The computer has several easy-to-read status indicators.



The front panel indicators are visible even when the computer cover is closed up.

No.	Icon	Item	Description
1		Power	Indicates the computer's power status.
2		Battery	Indicates the computer's battery status.
3		HDD	Indicates when the hard disk drive is active.
4		Num Lock	Lights up when Num Lock is activated.
5		Caps Lock	Lights up when Caps Lock is activated.





NOTE: 1. Charging: The light shows amber when the battery is charging.
2. Fully charged: The light shows green when in AC mode.

Easy-Launch Buttons

Located beside the keyboard are application buttons. These buttons are called easy-launch buttons. They are: WLAN, Internet, email, Bluetooth and Acer Empowering Technology.

The mail and Web browser buttons are pre-set to email and Internet programs, but can be reset by users. To set the Web browser, mail and programmable buttons, run the Acer Launch Manager.



No.	Icon	Item	Description
1		Empowering Technology	Launch Acer Empowering Technology. (user-programmable)
2		Wireless communication button/Indicator	Enable/disable the wireless function. Indicates the status of wireless LAN communication.
3		Web browser	Internet browser (user-Programmable)
4		Mail	Email application (user-Programmable)
5		Bluetooth communication button/indicator	Enable/disable the Bluetooth function. Indicates the status of Bluetooth communication.

Touchpad Basics

The following teaches you how to use the touchpad:

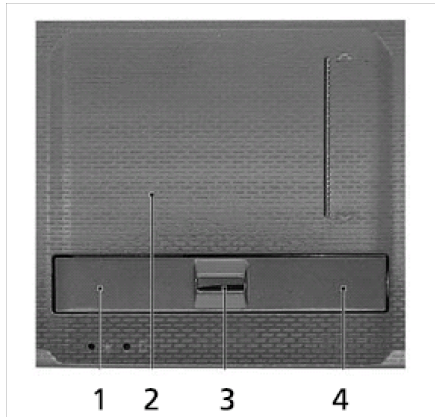

- ❑ Move your finger across the touchpad (2) to move the cursor.
- ❑ Press the left (1) and right (4) buttons located beneath the touchpad to perform selection and execution functions. These two buttons are similar to the left and right buttons on a mouse. Tapping on the touchpad is the same as clicking the left button.
- ❑ Use the 4-way scroll (3) button to scroll up or down and move left or right a page. This button mimics your cursor pressing on the right scroll bar of Windows applications.

Function	Left Button (1)	Right Button (4)	Main touchpad (2)	Center button (3)
Execute	Quickly click twice.		Tap twice (at the same speed as double-clicking a mouse button).	
Select	Click once.		Tap once.	
Drag	Click and hold, then use finger on the touchpad to drag the cursor.		Tap twice (at the same speed as double-clicking a mouse button); rest your finger on the touchpad on the second tap and drag the cursor.	
Access context menu		Click once.		
Scroll				Swipe up/down/left/right using Acer FingerNav 4-way control function (for selected models) or click and hold to move up/down/left/right (for selected models).

NOTE: When using the touchpad, keep it - and your fingers - dry and clean. The touchpad is sensitive to finger movements; hence, the lighter the touch, the better the response. Tapping too hard will not increase the touchpad's responsiveness.

Using the Keyboard

The keyboard has full-sized keys and an embedded keypad, separate cursor keys, two Windows keys and twelve function keys.

Lock Keys and embedded numeric keypad



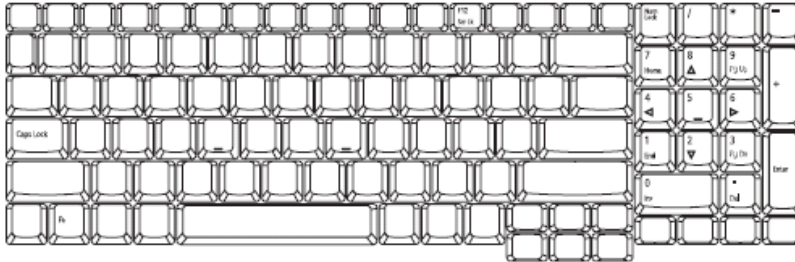















The keyboard has three lock keys which you can toggle on and off.



Lock key	Description
Caps Lock	When Caps Lock is on, all alphabetic characters typed are in uppercase.
Num Lock	When Num Lock is on, the separate keypad is in numeric mode. The keys function as a calculator (complete with the arithmetic operators +, -, *, and /). Use this mode when you need to do a lot of numeric data entry.
Scroll Lock <Fn> + <F12>	When Scroll Lock is on, the screen moves one line up or down when you press the up or down arrow keys respectively. Scroll Lock does not work with some applications.

Windows Keys

The keyboard has two keys that perform Windows-specific functions.

Key	Description
 Windows key	<p>Pressed alone, this key has the same effect as clicking on the Windows Start button; it launches the Start menu.</p> <p>It can also be used with other keys to provide a variety of functions:</p> <ul style="list-style-type: none"><  > : Open or close the Start menu<  > + <D>: Display the desktop<  > + <E>: Open Windows Explore<  > + <F>: Search for a file or folder<  > + <G>: Cycle through Sidebar gadgets<  > + <L>: Lock your computer (if you are connected to a network domain), or switch users (if you're not connected to a network domain)<  > + <M>: Minimizes all windows<  > + <R>: Open the Run dialog box<  > + <T>: Cycle through programs on the taskbar<  > + <U>: Open Ease of Access Center<  > + <X>: Open Windows Mobility Center<  > + <BREAK>: Display the System Properties dialog box<  > + <SHIFT+M>: Restore minimized windows to the desktop<  > + <TAB>: Cycle through programs on the taskbar by using Windows Flip 3-D<  > + <SPACEBAR>: Bring all gadgets to the front and select Windows Sidebar<CTRL> + <  > + <F>: Search for computers (if you are on a network)<CTRL> + <  > + <TAB>: Use the arrow keys to cycle through programs on the taskbar by using Windows Flip 3-D <p>Note: Depending on your edition of Windows Vista or Windows XP, some shortcuts may not function as described.</p>
 Application key	<p>This key has the same effect as clicking the right mouse button; it opens the application's context menu.</p>

Hot Keys

The computer employs hotkeys or key combinations to access most of the computer's controls like screen brightness, volume output and the BIOS utility.

To activate hot keys, press and hold the <Fn> key before pressing the other key in the hotkey combination.

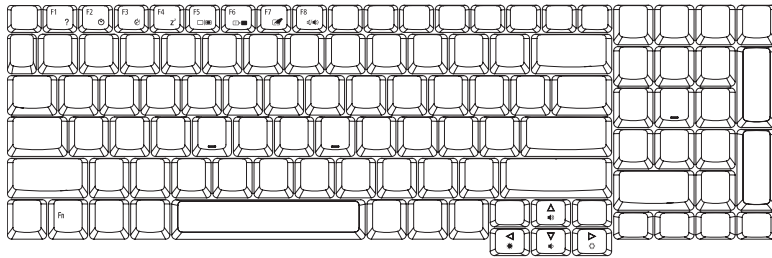

Hotkey	Icon	Function	Description
<Fn> + <F1>	?	Hotkey help	Displays help on hotkeys.
<Fn> + <F2>		Acer eSettings	Launches Acer eSettings in Acer Empowering Technology.
<Fn> + <F3>		Acer ePower Management	Launches Acer ePower Management in Acer Empowering Technology.
<Fn> + <F4>	Zz	Sleep	Puts the computer in Sleep mode.
<Fn> + <F5>		Display toggle	Switches display output between the display screen, external monitor (if connected) and both.
<Fn> + <F6>		Screen blank	Turns the display screen backlight off to save power. Press any key to return.
<Fn> + <F7>		Touchpad toggle	Turns the internal touchpad on and off.
<Fn> + <F8>		Speaker toggle	Turns the speakers on and off.
<Fn> + <↑>		Volume up	Increases the sound volume.
<Fn> + <↓>		Volume down	Decrease the sound volume.
<Fn> + <←>		Brightness up	Increases the screen brightness.
<Fn> + <→>		Brightness down	Decreases the screen brightness.

Special Key

You can locate the Euro symbol and US dollar sign at the upper-center and/or bottom-right of your keyboard. To type:

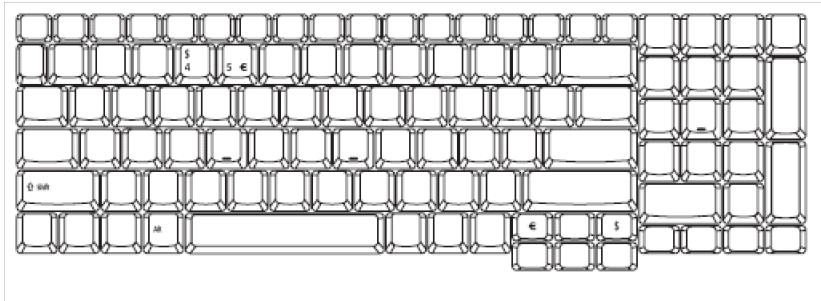

The Euro symbol

1. Open a text editor or word processor.
2. Either directly press the <€> symbol at the bottom-right of the keyboard, or hold <Alt Gr> and then press the <5> symbol at the upper-center of the keyboard.

NOTE: Some fonts and software do not support the Euro symbol. Please refer to www.microsoft.com/typography/faq/faq12.htm for more information.

The US dollar sign

1. Open a text editor or word processor.
2. Either directly press the <\$> key at the bottom-right of the keyboard, or hold <Shift> and then press the <4> key at the upper-center of the keyboard.

NOTE: This function varies by the operating system version.

Acer Empowering Technology

The Empowering Technology toolbar makes it easy for you to access frequently used functions and manage your new Acer system. Activated by pressing the Empowering Key, it provides access to the following utilities:

NOTE: The following content is for general reference only. Actual product specifications may vary.

- ❑ Acer eAudio Management allows you to easily control the enhanced sound effects of Dolby Home Theater on your system.
- ❑ Acer ePower Management optimizes battery usage via customizable power plans.
- ❑ Acer eDataSecurity Management protects data with passwords and encryption (for selected models).
- ❑ Acer eRecovery Management backs up and recovers data flexibly, reliably and completely.
- ❑ Acer eSettings Management accesses system information and adjusts settings easily.



For more information, right-click on the Empowering Technology toolbar, then select Help.

For help with a particular utility, launch the utility and click the  icon at the bottom of the active window. Launching Acer Empowering Technology

To launch Acer Empowering Technology:

- ❑ Press the Empowering Key to display the Acer Empowering Technology toolbar on the desktop.
- ❑ To hide the toolbar, press the Empowering Key again or click the hide button on the toolbar.

You may also launch Acer Empowering Technology by running the program from the Acer Empowering Technology program group in the Start menu, or by double-clicking the icon if you have created a desktop shortcut.

To launch Acer Empowering Technology applications:

- ❑ On the Acer Empowering Technology toolbar, click the icon that corresponds to the application you want to launch.
- ❑ When you mouse over an application icon, a quick menu appears below the toolbar. The quick menu allows you to perform certain tasks simply and quickly.
- ❑ You may also run the application by selecting it from the Acer Empowering Technology program group in the Start menu.



Acer eAudio Management

Acer eAudio Management allows you to easily control the enhanced sound effects of Dolby Home Theater on your system. Select Movie or Game mode to experience the awesome realism of 5.1-channel surround sound from just two speakers, via Dolby Virtual Speaker technology. Music mode lets you enjoy your favorite tunes, in vivid detail.



To choose your playback device, click the icon on the upper right side of the Acer eAudio Management window.

Acer ePower Management

Acer ePower Management features a straightforward user interface for configuring your power management options. To access this utility, select Acer ePower Management from the Empowering Technology toolbar, run the program from the Acer Empowering Technology program group in Start menu, or right-click the Windows power icon in the system tray and select Acer ePower Management.

Using power plans

Acer ePower Management comes with three predefined power plans: Balanced, High performance and Power saver. You can also create customized power plans. You can create, switch between, edit, delete and restore power plans, as described below View and adjust settings for On Battery and Plugged In modes by clicking the appropriate tabs. For more power options, click in the Acer ePower and select Power Options.

To create a new power plan:

Creating customized power plans allows you to save and quickly switch to a personalized set of power options.

1. Click the New power plan option or icon.
2. Enter a name for your new power plan.
3. Choose a predefined power plan to base your customized plan on.
4. If necessary, change the display, sleep and hibernation settings you want your computer to use.
5. Click OK to save your new power plan.

To switch between power plans:

1. Mouse over the Acer ePower Management application on the Acer Empowering Technology toolbar. The quick menu appears
2. Select the power plan you want to switch to You may also switch between power plans by launching the Acer ePower Management application. Select the power plan you wish to switch to, then click Apply. click Apply

To edit a power plan:

Editing a power plan allows you to adjust system settings like LCD brightness and CPU speed.

1. Switch to the power plan you wish to edit.
2. Adjust settings as required.
3. Click Apply to save your new settings.

To delete a power plan:

You cannot delete the power plan you are currently using. If you want to delete the active power plan, switch to another one first.

1. Select the power plan you wish to delete.
2. Click the Delete Power Plan icon.

Battery status

The quick menu shows the remaining battery life based on current usage. You can also launch the Acer ePower Management application and refer to the Battery status panel located just below the power plans. Click the Battery tab to view remaining battery life, battery status, and remaining battery life in standby and hibernate modes.



Acer eDataSecurity Management

(for selected models) 

Acer eDataSecurity Management is an encryption utility that protects your files from being accessed by unauthorized persons. It is conveniently integrated with Windows Explorer as a shell extension for quick data encryption/decryption and also supports on-the-fly file encryption for Lotus Notes and Microsoft Outlook.

On first use, the Acer eDataSecurity Management setup wizard will prompt you to create the Master Password. You will use this password to access the Personal Secure Disk (PSD). The Master Password may also be used to encrypt/decrypt files by default.

If you set a different password to encrypt a file, but you forgot the encryption password, you can use the Master Password to decrypt the file.



Acer eRecovery Management

Acer eRecovery Management is a versatile backup utility. It allows you to create full or incremental backups, burn the factory default image to optical disc, and restore from previously created backups or reinstall applications and drivers. By default, user-created backups are stored to the D:\ drive.system's HDD. User-created backups are stored on D:\ drive. Acer eRecovery Management provides you with:

- Password protection.
- Recovery of applications and drivers.
- Image/data backup:
 - Back up to HDD (set recovery point).
 - Back up to CD/DVD.

Image/data recovery tools:

- Recover from a hidden partition (factory defaults).
- Recover from the HDD (most recent user-defined recovery point).
- Recover from CD/DVD.



For more information, please refer to “Acer eRecovery Management”

NOTE: If your computer did not come with a Recovery CD or System CD, please use Acer eRecovery Management’s “System backup to optical disk” feature to burn a backup image to CD or DVD. To ensure the best results when recovering your system using a CD or Acer eRecovery Management, detach all peripherals (except the external Acer ODD, if your computer has one), including your Acer ezDock.

Acer eSettings Management

Acer eSettings Management allows you to inspect hardware specifications and to monitor the system health status. Furthermore, Acer eSettings Management enables you to optimize your Windows operating system, so your computer runs faster, smoother and better.

Acer eSettings Management also:

Provides a simple graphical user interface for navigating.

Displays general system status and advanced monitoring for power users.

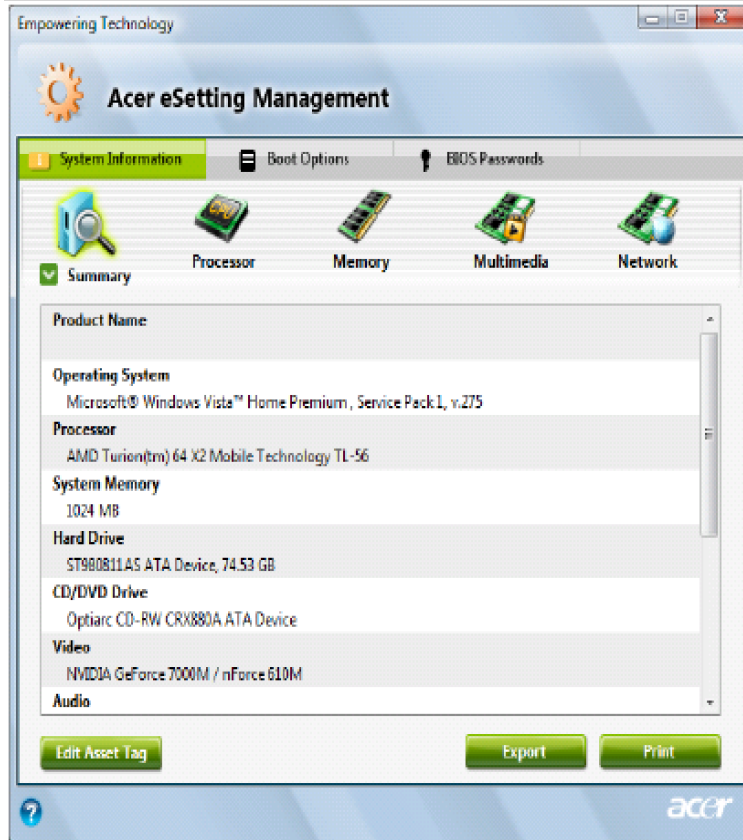

Windows Mobility Center

The Windows Mobility Center collects key mobile-related system settings in one easy-to-find place, so you can quickly configure your Acer system to fit the situation as you change locations, networks or activities. Settings include display brightness, power plan, volume, wireless networking on/off, external display settings, display orientation and synchronization status.

Windows Mobility Center also includes Acer-specific settings like Bluetooth Add Device (if applicable), sharing folders overview/sharing service on or off, and a shortcut to the Acer user guide, drivers and utilities. To launch Windows Mobility Center:

- Use the shortcut key <Windows> + <X>.
- Start Windows Mobility Center from the Control panel.
- Start Windows Mobility Center from the Accessories program group in the Start menu.

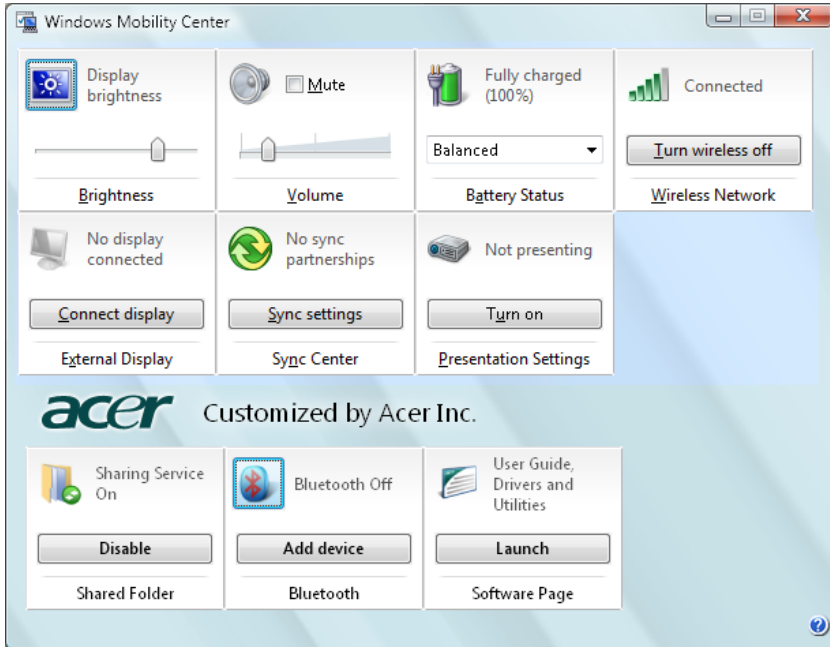

Using the System Utilities

Acer Bio-Protection (for selected models)

Acer Bio-Protection Fingerprint Solution is a multi-purpose fingerprint software package integrated with the Microsoft Windows operating system. Utilizing the uniqueness of one's fingerprint features, Acer Bio-Protection Fingerprint Solution has incorporated protection against unauthorized access to your computer with centralized password management with Password Bank, easy music player launching with Acer MusicLaunch, secure Internet favorites via Acer MyLaunch, and fast application/website launching and login with Acer FingerLaunch, while Acer ProfileLaunch can launch up to three applications/ websites from a single finger swipe.

Acer Bio-Protection Fingerprint Solution also allows you to navigate through web browsers and documents using Acer FingerNav. With Acer Bio-Protection Fingerprint Solution, you can now enjoy an extra layer of protection for your personal computer, as well as the convenience of accessing your daily tasks with a simple swipe of your finger.

For more information refer to the Acer Bio-Protection help files.

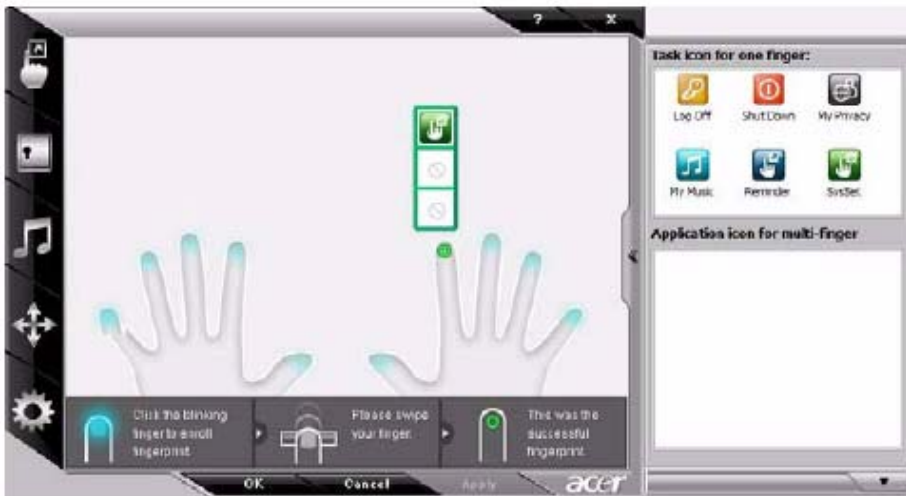

Acer GridVista (dual-display compatible)

NOTE: This feature is only available on certain models.

To enable the dual display feature of your notebook, first ensure that a second display is connected, then, open the Display Settings properties box using the Control Panel or by right-clicking the Windows desktop and selecting **Personalize**. Select the secondary monitor (**2**) icon in the display box and then click the check box **Extend the desktop onto this monitor**. Finally, click **Apply** to confirm the new settings and click **OK** to complete the process.

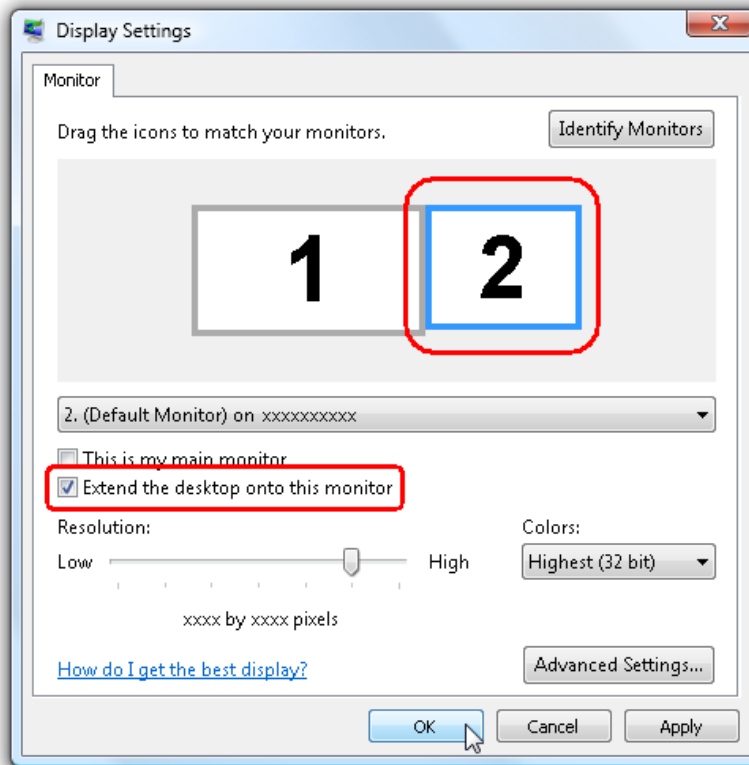

Acer GridVista is a handy utility that offers four pre-defined display settings so you can view multiple windows on the same screen. To access this function, please go to **Start, All Programs** and click on **Acer GridVista**. You may choose any one of the four display settings indicated below:



Double (vertical), Triple (primary at left), Triple (primary at right), or Quad Acer GridVista is dual-display compatible, allowing two displays to be partitioned independently.

Acer GridVista is dual-display compatible, allowing two displays to be partitioned independently.

AcerGridVista is simple to set up:

1. Run Acer GridVista and select your preferred screen configuration for each display from the task bar.
2. Drag and drop each window into the appropriate grid.

3. Enjoy the convenience of a well-organized desktop.

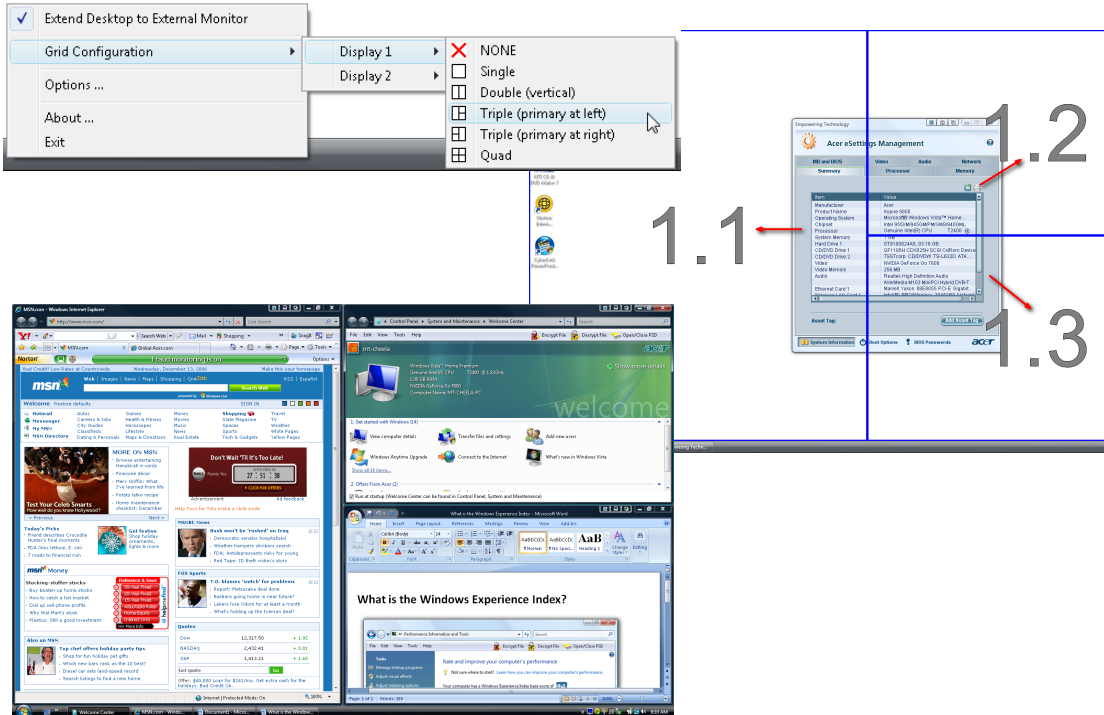

NOTE: Please ensure that the resolution setting of the second monitor is set to the manufacturer's recommended value.

Launch Manager

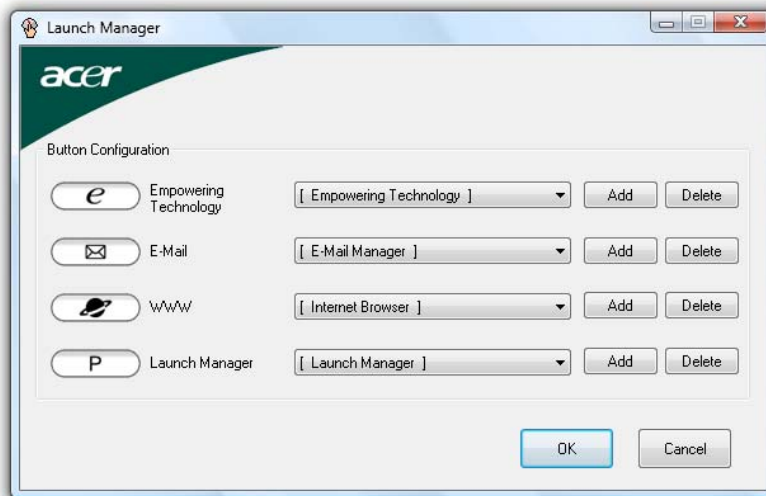

Launch Manager allows you to set the four easy-launch buttons located above the keyboard. You can access the Launch Manager by clicking on **Start > All Programs > Launch Manager** to start the application.

Hardware Specifications and Configurations

Processor

Item	Specification
CPU type	Intel CPU Penryn
Core logic	Intel 975PM + ICH9M
CPU package	uFCPGA, Socket P
CPU core voltage	0.944~1.3V

Second Level Cache

Item	Specification
Cache controller	Built-in CPU
Cache size	6MB
1st level cache control	Always enabled
2st level cache control	Always enabled
Cache scheme control	Fixed in write-back

System Memory

Item	Specification
Memory controller	Intel PM975
Memory size	0MB (no on-board memory)
DIMM socket number	2 sockets
Supports memory size per socket	2GB
Supports maximum memory size	4GB
Supports DIMM type	DDR 3 Synchronous DRAM
Supports DIMM Speed	800/1066 MHz
Supports DIMM voltage	1.8V and 0.9V
Supports DIMM package	200-pin soDIMM

Lan Interface

Item	Specification
Chipset	ATHEROS_AR8121
Supports LAN protocol	10/100/1000 Ethernet
PCI-E Giga	
LAN connector type	RJ45
LAN connector location	Left side
Features	Integrated 10/100/1000 BASE-T transceiver

Modem Interface

Item	Specification
Data modem data baud rate (bps)	56K
Supports modem protocol	V.92
Modem connector type	RJ11
Modem connector location	Left side

Bluetooth Interface

Item	Specification
Chipset	Built-in ICH8M
Data throughput	723 bps (full speed data rate)
Protocol	Bluetooth 1.1 (Upgradeable to Bluetooth 1.2 when SIG specification is ratified).
Interface	USB 2.0
Connector type	USB

Hard Disk Drive Interface

Item	Specification		
Vendor & Model Name	HGST HTS541680J9SA00 WD WD800BEVS-22RST0	Seagate ST9120822AS Toshiba MK1237GSX HGST HTS541612J9SA00 WD WD1200BEVS-22RST0	TOSHIBA MK1637GSX SEAGATE ST9160821AS HGST HTS541616J9SA00 WD WD1600BEVS-22RST0
Capacity (MB)	80000	120000	160000
Bytes per sector	512		
Data heads	2		
4 for Toshiba and HGST	4		
Drive Format			
Disks	1		
Spindle speed (RPM)	5400 RPM		
Performance Specifications			
Buffer size	8M		
Interface	SATA		
Max. media transfer rate (disk-buffer, Mbytes/s)	100,150		
Data transfer rate (host~buffer, Mbytes/s)			
Ultra DMA mode-5	100 MB/Sec.		
DC Power Requirements			
Voltage tolerance	5V(DC) +/- 5%		
Data transfer rate (host~buffer, Mbytes/s)			
Ultra DMA mode-5	100 MB/Sec.		
DC Power Requirements			
Voltage tolerance	5V(DC) +/- 5%		

DVD-Super Multi Interface

Item	Specification
Vendor & model name	TOSHIBA 8X TS-L632D PHILIPS 8X DS-8A1P HLDS 8X GSA-T20N
Performance Specification	With CD Diskette
Transfer rate (KB/sec)	Sustained:Max 3.6Mbytes/sec Sustained:Max 10.8Mbytes/sec
Buffer Memory	2MB
Interface	Enhanced IDE(ATAPI) compatible
Applicable disc format	
Support disc formats	<ol style="list-style-type: none"> 1. Reads data in each CD-ROM, CD-ROM XA, CD-1, Video CD, CD-Extra and CD-Plus 2. Reads data in super Audio CD (SACD) Hybrid type 3. Reads standard CD-DA 4. Reads and writes CD-R discs 5. Reads and writes CD-RW and HSRW discs 6. Reads and writes US & US+RW 7. Reads data in each DVD-ROM and DVD-Dual 8. Reads and writes in each DVD-R (Ver. 2.0 for general), DVD-RW and DVD+R/RW (Ver1.1) 9. Reads and writes DVD+-R Dual 10. Reads and writes DVD-RAM
Loading mechanism	Load: Manual Release: (a) Electrical Release (Release Button) (b) Release by ATAPI command (c) Emergency Release
Power Requirement	
Input Voltage	5 V +/- 5 % (Operating)

Audio Interface

Item	Specification
Audio Controller	Realtek ALC889X
Audio onboard or optional	Built-in
Mono or Stereo	Stereo
Resolution	24 bit stereo full duplex
Compatibility	HD audio Interface; S/PDIF output for PCM or AC-3 content
Sampling rate	1Hz resolution VSR (Variable Sampling Rate)
Internal microphone	Yes
Internal speaker / Quantity	Yes/2(3W speakers)
Supports PnP DMA channel	DMA channel 0 DMA channel 1
Supports PnP IRQ	IRQ10, IRQ11

Video Interface

Item	Specification
Chipset	Acer MXM compatible

USB Port

Item	Specification
Chipset	Built-in ICH8M
USB Compliancy Level	2
OHCI	USB 1.1 and USB 2.0 Host controller
Number of USB port	4
Location	One on the left side; three on the right side
Serial port function control	Enable/Disable by BIOS Setup

Express Card Interface

Item	Specification
Express card controller	Built-in ICH8M
Supports card type	75mmx54mm(W)x5mm
Number of slots	One
Access location	Left Side
Interface	PCI Express

System Board Major Chips

Item	Specification
Core logic	Intel PM975 + ICH8M
VGA	Acer MXM compatible
LAN	ATHEROS_AR8121
USB 2.0	Built in ICH8M
CardReader	Jmicro JMB385
MODEM	Foxconn T60M955
Bluetooth	Foxconn T60H928.11
Wireless 802.11 a+b+g	Built-in ICH8-M
Audio	Realtek ALC889X

Keyboard

Item	Specification
Keyboard controller	ITE 8512E
Total number of keypads	88-/89-key
Windows logo key	Yes
Internal & external keyboard work simultaneously	Plug USB keyboard to the USB port directly: Yes

Battery

Item	Specification
Vendor & Model Name	BATTERY PACK SANYO LI-ION 8 CELL2.4, 4800MAH BATTERY PACK SONY LI-ION 8CELL2.4, 4800MAH
Battery Type	Li-ion
Pack capacity	4800 mAh
Number of battery cell	8 cell
Package configuration	4 cells in series, 2 series in parallel
Normal voltage	14.8V
Charge voltage	16.8+-0.2V

LCD 18.0" inch

Item	Specification
Vendor & model name	Samsung LNT184HT01-A01
Screen Diagonal (mm)	18.4 inches
Active Area (mm)	353.45(H) x 198.72(V) mm
Display resolution (pixels)	1920x1080 WUXGA
Pixel Pitch	0.213 (H) x 0.213(V) mm
Pixel Arrangement	R.G.B. Vertical Stripe
Display Mode	Normally White
Typical White Luminance (cd/m2) also called Brightness	300
Luminance Uniformity	N/A
Contrast Ratio	600
Response Time (Optical Rise Time/Fall Time) msec	8
Nominal Input Voltage VDD	+3.3V
Typical Power Consumption (watt)	4.5W
Weight(g)	550g
Physical Size(mm)	365x214x6.5
Electrical Interface	Dual channel LVDS
Support Color	262,144
Viewing Angle (degree)	
Horizontal: Right/Left	65/65
Vertical: Upper/Lower	50/50

Item	Specification
Temperature Range(°C)	
Operating	0 to +50
Storage (shipping)	-20 to +60

LCD Inverter

Item	Specification
Vendor & model name	TDK
Brightness conditions	N/A
Input voltage (V)	9~20V
Input current (mA)	360mA (max)
Output voltage (V, rms)	710V (1800V for kick off)
Output current (mA, rms)	6.5mA (max)
Output voltage frequency (k Hz)	58 KHz (max)

AC Adaptor

Item	Specification
Input rating	100V AC to 240V AC, 47Hz to 63Hz
Maximum input AC current	1.5A
Inrush current	50A@115VAC 100A@230VAC
Efficiency	85% min. @115VAC input full load

System Power Management

ACPI mode	Power Management
Mech. Off (G3)	All devices in the system are turned off completely.
Soft Off (G2/S5)	OS initiated shutdown. All devices in the system are turned off completely.
Working (G0/S0)	Individual devices such as the CPU and hard disc may be power managed in this state.
Suspend to RAM (S3)	CPU set power down VGA Suspend PCMCIA Suspend Audio Power Down Hard Disk Power Down CD-ROM Power Down Super I/O Low Power mode
Save to Disk (S4)	Also called Hibernation Mode. System saves all system states and data onto the disc prior to power off the whole system.

System Utilities

BIOS Setup Utility

The BIOS Setup Utility is a hardware configuration program built into your computer's BIOS (Basic Input/Output System).

Your computer is already properly configured and optimized, and you do not need to run this utility. However, if you encounter configuration problems, you may need to run Setup. Please also refer to Chapter 4 Troubleshooting when problem arises.

To activate the BIOS Utility, press F2 to enter Setup Menu.

The default parameter of F12 Boot Menu is set to "disabled". If you want to change boot device without entering BIOS Setup Utility, please set the parameter to "enabled".

Press <F12> during POST to enter multi-boot menu. In this menu, user can change boot device without entering BIOS SETUP Utility.

InsydeH2O Setup Utility		Rev. 3.0
Information	Main	Security
Boot	Exit	
CPU Type:	Genuine Intel(R) CPU	
CPU Speed:	T2300 @ 1.66GHz	
IDE 0 Model Name: <i>(Note1)</i>	ST960821A-(PM)	
IDE0 Serial Number: <i>(Note1)</i>	3LF005DB	
ATAPI Model Name:	MATSHITADVD	
System BIOS Version:	V1.00	
VGA BIOS Version:	ATI V008.050I.0-26.00	
Serial Number:	xxxxxxxxxxxxxxxxxxxx (Max: 22 Byte)	
Asset Tag Number:	xxxxxxxxxxxxxxxxxxxx (Max: 32 Byte)	
Product Name:	xxxxxxxxxxxxxxxxxxxx (Max: 16 Byte)	
Manufacturer Name:	Acer	
UUID:	xxxxxxxxxxxxxxxxxxxx (Max: 16 Byte)	
F1 Help ↑↓ Select Item F5/F6 Change Values F9 Setup defaults Esc Exit ←→ Select Menu Enter Select ▸ Sub-Menu F10 Save and Exit		

Invoking BIOS Setup

The setup function can only be invoked by pressing F2 when Press <F2> to enter Setup message is prompted on the bottom of screen during POST.

The setup uses a menu driven interface to allow the user to configure their system. The features are divided into 5 parts as follows:

Information	Display the system informations.
Main	allows the user to specify standard IBM PC AT system parameters.
Security	Provides security settings of the system.
Boot	Allows the user to specify the boot options.
Exit	Allows the user to save CMOS setting and exit Setup.

NOTE: You can change the value of a parameter if it is enclosed in square brackets. Navigation keys for a particular menu are shown on the bottom of the screen. Help for parameters are found in the Item Specific Help part of the screen. Read this carefully when making changes to parameter values.

Please note that system information is subject to different models.

Information

InsydeH2O Setup Utility		Rev. 3.0
Information	Main	Security
Boot	Exit	
CPU Type:	Genuine Intel(R) CPU	
CPU Speed:	T2300 @ 1.66GHz	
IDE 0 Model Name: <i>(Note1)</i>	ST960821A-(PM)	
IDE0 Serial Number: <i>(Note1)</i>	3LF005DB	
ATAPI Model Name:	MATSHITADVD	
System BIOS Version:	V1.00	
VGA BIOS Version:	ATI V008.050I.0-26.00	
Serial Number:	xxxxxxxxxxxxxxxxxxxx (Max: 22 Byte)	
Asset Tag Number:	xxxxxxxxxxxxxxxxxxxx (Max: 32 Byte)	
Product Name:	xxxxxxxxxxxxxxxxxxxx (Max: 16 Byte)	
Manufacturer Name:	Acer	
UUID:	xxxxxxxxxxxxxxxxxxxx (Max: 16 Byte)	
F1 Help ↑↓ Select Item F5/F6 Change Values F9 Setup defaults Esc Exit ←→ Select Menu Enter Select ▸ Sub-Menu F10 Save and Exit		

NOTE: The system information is subject to different models.

Parameter	Description
CPU Type	This field shows the CPU type and speed of the system.
IDE1 Model Name	This field shows the model name of HDD installed on primary IDE master.
IDE1 Serial Number	This field displays the serial number of HDD installed on primary IDE master.
IDE2I Model Name	This field displays the mofel name of devices installed on secondary IDE master. The hard disk drive or optical drive model name is automatically detected by the system.
IDE2 Serial Number	This field shows the serial number of devices installed on secondary IDE master.
System BIOS ver	Displays system BIOS version.
VGA BIOS Ver	This field displays the VGA firmware version of the system.
Serial Number	This field displays the serial number of this unit.
Asset Tag Number	This field displays the asset tag number of the system.
Product Name	This field shows product name of the system.
Manufacturer Name	This field displays the manufacturer of this system.
UUID Number	This will be visible only when an internal LAN device is presenting. UUID=32bytes

Main

The Main screen displays a summary of your computer hardware information, and also includes basic setup parameters. It allows the user to specify standard IBM PC AT system parameters.

InsydeH2O Setup Utility		Rev. 3.0
Information	Main	Security Boot Exit
System Time: [09:00:00] System Date: [01/01/2003] Total Memory [xxxxMB] Video Memory: [8MB] <i>(note2)</i> Quiet Boot: [Enabled] Network boot: [Enabled] F12 Boot Menu: [Disabled] D2D Recovery: [Enabled]		Item specific Help <Tab>, <Shift-Tab>, or <Enter> selects field
F1 Help ↑↓ Select Item F5/F6 Change Values F9 Setup defaults Esc Exit ←→ Select Menu Enter Select ▸ Sub-Menu F10 Save and Exit		

NOTE: The screen above is for your reference only. Actual values may differ.

The table below describes the parameters in this screen. Settings in **boldface** are the default and suggested parameter settings.

Parameter	Description	Format/Option
System Time	Sets the system time. The hours are displayed with 24-hour format.	Format: HH:MM:SS (hour:minute:second) System Time
System Date	Sets the system date.	Format MM/DD/YYYY (month/day/year) System Date
Total Memory	This field reports the memory size of the total memory in the system.	
VGA Memory	Shows the VGA memory size. VGA Memory size=64/128MB	
Quiet Boot	Determines if Customer Logo will be displayed or not; shows Summary Screen is disabled or enabled. Enabled: Customer Logo is displayed, and Summary Screen is disabled. Disabled: Customer Logo is not displayed, and Summary Screen is enabled.	Option: Enabled or Disabled
Network Boot	Enables, disables the system boot from LAN (remote server).	Option: Enabled or Disabled
F12 Boot Menu	Enables, disables Boot Menu during POST.	Option: Disabled or Enabled
D2D Recovery	Enables, disables D2D Recovery function. The function allows the user to create a hidden partition on hard disc drive to store operation system and restore the system to factory defaults.	Option: Enabled or Disabled
SATA Mode	Set harddisk controller configure type	

NOTE: The sub-items under each device will not be shown if the device control is set to disable or auto. This is because the user is not allowed to control the settings in these cases.

Security

The Security screen contains parameters that help safeguard and protect your computer from unauthorized use.

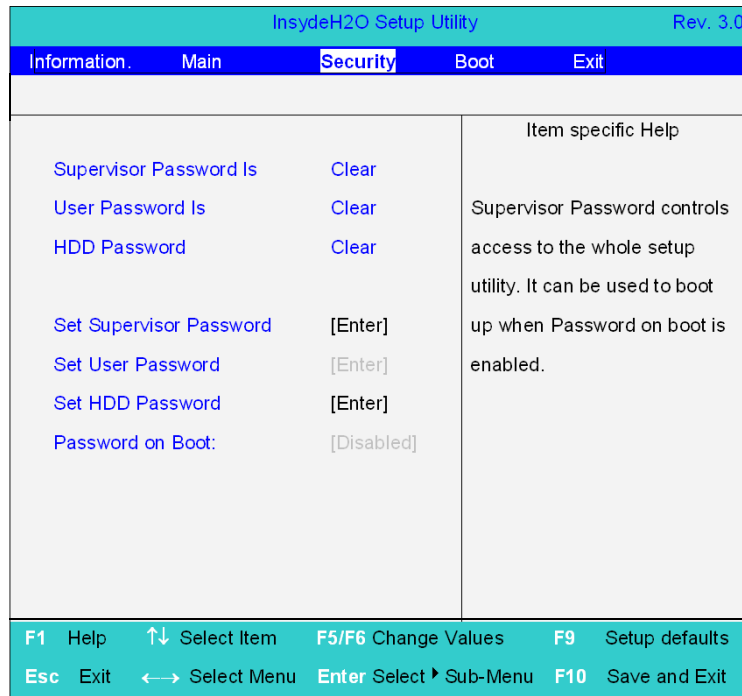

The table below describes the parameters in this screen. Settings in **boldface** are the default and suggested parameter settings.

Parameter	Description	Option
User Password is	Shows the setting of the user password.	Clear or Set
Supervisor Password is	Shows the setting of the Supervisor password	Clear or Set
Set User Password	Press Enter to set the user password. When user password is set, this password protects the BIOS Setup Utility from unauthorized access. The user can enter Setup menu only and does not have right to change the value of parameters.	
Set Supervisor Password	Press Enter to set the supervisor password. When set, this password protects the BIOS Setup Utility from unauthorized access. The user can not either enter the Setup menu nor change the value of parameters.	
HardDisk Security	Enables or disables primary hard disk security function.	
Password on Boot	Defines whether a password is required or not while the events defined in this group happened. The following sub-options are all requires the Supervisor password for changes and should be grayed out if the user password was used to enter setup.	Disabled or Enabled

NOTE: When you are prompted to enter a password, you have three tries before the system halts. Don't forget your password. If you forget your password, you may have to return your notebook computer to your dealer to reset it.

Setting a Password

Follow these steps as you set the user or the supervisor password:

1. Use the **w** and **y** keys to highlight the Set Supervisor Password parameter and press the **e** key. The Set Supervisor Password box appears:

Set Supervisor Password		
Enter New Password	[]
Confirm New Password	[]

2. Type a password in the "Enter New Password" field. The password length can not exceeds 8 alphanumeric characters (A-Z, a-z, 0-9, not case sensitive). Retype the password in the "Confirm New Password" field.

IMPORTANT: Be very careful when typing your password because the characters do not appear on the screen.

3. Press **e**.
After setting the password, the computer sets the User Password parameter to "Set".
4. If desired, you can opt to enable the Password on boot parameter.
5. When you are done, press **u** to save the changes and exit the BIOS Setup Utility.

Removing a Password

Follow these steps:

1. Use the **w** and **y** keys to highlight the Set Supervisor Password parameter and press the **e** key. The Set Password box appears:

Set Supervisor Password		
Enter current password	[]
Enter New Password	[]
Confirm New Password	[]

2. Type the current password in the Enter Current Password field and press **e**.
3. Press **e** twice **without** typing anything in the Enter New Password and Confirm New Password fields. The computer then sets the Supervisor Password parameter to "Clear".
4. When you have changed the settings, press **u** to save the changes and exit the BIOS Setup Utility.

Changing a Password

1. Use the `w` and `y` keys to highlight the Set Supervisor Password parameter and press the `e` key. The Set Password box appears:

Set Supervisor Password		
Enter current password	[]
Enter New Password	[]
Confirm New Password	[]

2. Type the current password in the Enter Current Password field and press `e`.
3. Type a password in the Enter New Password field. Retype the password in the Confirm New Password field.
4. Press `e`. After setting the password, the computer sets the User Password parameter to "Set".
5. If desired, you can enable the Password on boot parameter.
6. When you are done, press `u` to save the changes and exit the BIOS Setup Utility.

If the verification is OK, the screen will display as following.

Setup Notice
Changes have been saved.
[continue]

The password setting is complete after the user presses `u`.

If the current password entered does not match the actual current password, the screen will show you the Setup Warning.

Setup Warning
Invalid password
Re-enter Password
[continue]

If the new password and confirm new password strings do not match, the screen will display the following message.

Setup Warning
Password do not match
Re-enter Password

Boot

This menu allows the user to decide the order of boot devices to load the operating system. Bootable devices includes the distette drive in module bay, the onboard hard disk drive and the CD-ROM in module bay.

InsydeH2O Setup Utility		Rev. 3.0		
Information	Main	Security	Boot	Exit
Boot priority order:		Item specific Help		
1. IDE 0: ST960821A		Use <↑> or <↓> to select a device, then press <F6> to move it up the List, or <F5> to move it down the list. Press <Esc> to escape the menu		
2. IDE 1: MATSHITADVD				
3. USB FDD:				
4. Network Boot: Realtek Boot Agent				
5. USB HDD:				
6. USB KEY:				
7. USB CDROM:				
F1 Help	↑↓ Select Item	F5/F6 Change Values	F9 Setup defaults	
Esc Exit	←→ Select Menu	Enter Select	▶ Sub-Menu	F10 Save and Exit

Exit

The Exit screen contains parameters that help safeguard and protect your computer from unauthorized use.

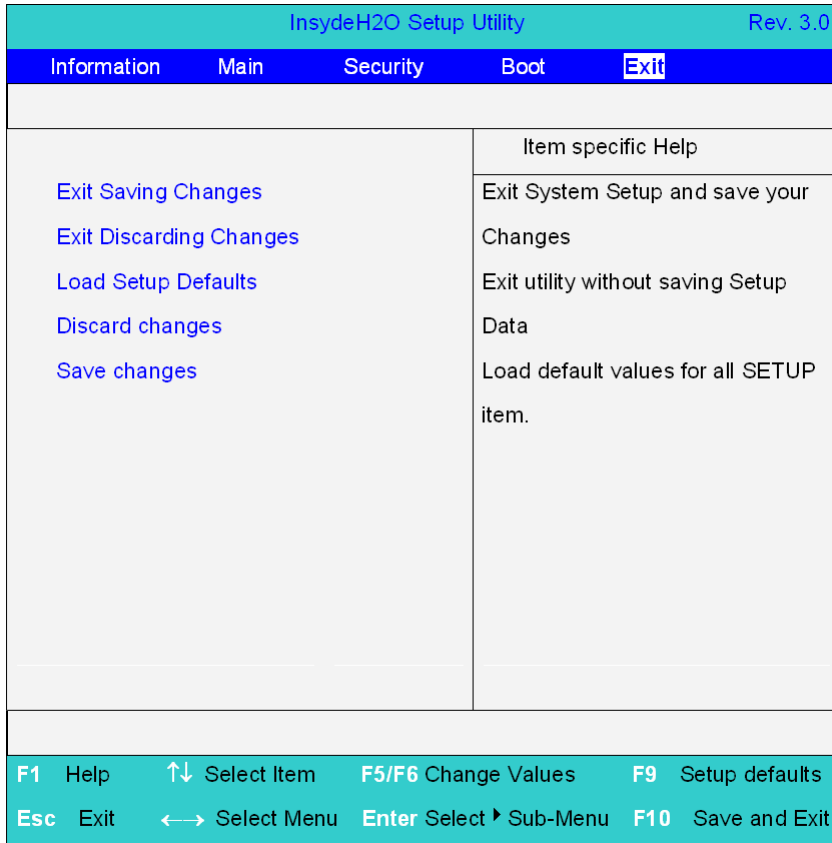

The table below describes the parameters in this screen.

Parameter	Description
Exit Saving Changes	Exit System Setup and save your changes to CMOS.
Exit Discarding Changes	Exit utility without saving setup data to CMOS.
Load Setup Default	Load default values for all SETUP item.
Discard Changes	Load previous values from CMOS for all SETUP items.
Save Changes	Save Setup Data to CMOS.

BIOS Flash Utility

The BIOS flash memory update is required for the following conditions:

- New versions of system programs
- New features or options
- Restore a BIOS when it becomes corrupted.

Use the Phlash utility to update the system BIOS flash ROM.

NOTE: Do not install memory-related drivers (XMS, EMS, DPMI) when you use the Phlash.

NOTE: Please use the AC adaptor power supply when you run the Phlash utility. If the battery pack does not contain enough power to finish BIOS flash, you may not boot the system because the BIOS is not completely loaded.

Follow the steps below to run the Phlash.

1. Prepare a bootable diskette.
2. Copy the flash utilities to the bootable diskette.
3. Then boot the system from the bootable diskette. The flash utility has auto-execution function.

BIOS Crisis Recovery

Follow the steps below to run the BIOS Crisis Recovery.

1. Download the BIOS image.
2. Copy the BIOS image file XXXXXXXX.FD to the root folder of USB Key and rename it to KM2X64.FD.
3. Connect AC adapter and the USB key.
4. Press "Fn+ESC" and "Power button", the system will do the BIOS Crisis Recovery.

There is no display on the screen during Crisis, please wait for 2 minutes at least.

System will reboot after finish doing Crisis.

Unlock HDD password Utility

If you key in wrong HDD password for three times, error code would display on the screen. See the image below.

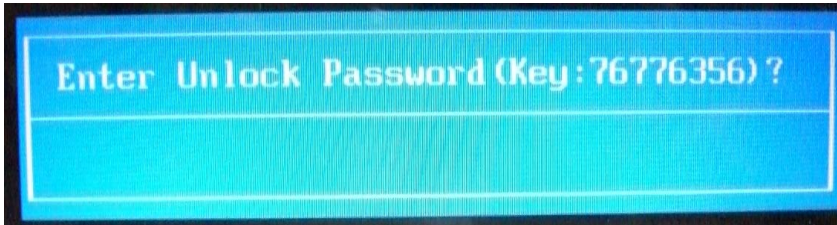

If you need to solve HDD password locked problem, you can run UNLOCKHD.EXE to generate unlock password.

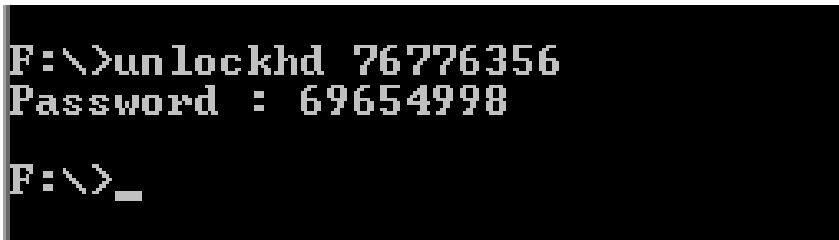

Key in generate unlock password.

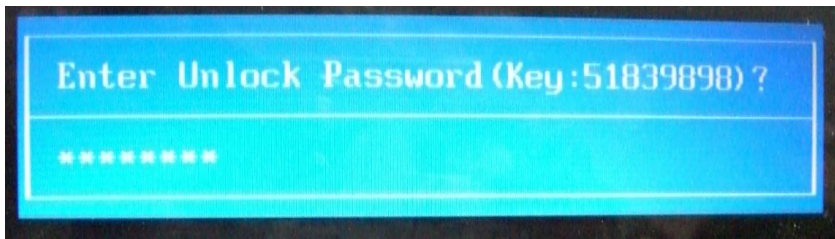

Machine Disassembly and Replacement

This chapter contains step-by-step procedures on how to disassemble the notebook computer Aspire 8930Q for maintenance and troubleshooting.

To disassemble the computer, you need the following tools:

- Wrist grounding strap and conductive mat for preventing electrostatic discharge
- Small Philips screw driver
- Philips screwdriver
- Plastic flat head screw driver
- Tweezers

NOTE: The screws for the different components vary in size. During the disassembly process, group the screws with the corresponding components to avoid mismatch when putting back the components. When you remove the stripe cover, please be careful not to scrape the cover.

General Information

Before You Begin

Before proceeding with the disassembly procedure, make sure that you do the following:

1. Turn off the power to the system and all peripherals.
2. Unplug the AC adapter and all power and signal cables from the system.
3. Remove the battery pack.

Disassembly Procedure Flowchart

The flowchart on the succeeding page gives you a graphic representation on the entire disassembly sequence and instructs you on the components that need to be removed during servicing. For example, if you want to remove the system board, you must first remove the keyboard, then disassemble the inside assembly frame in that order.

Main unit disassembly flow chart

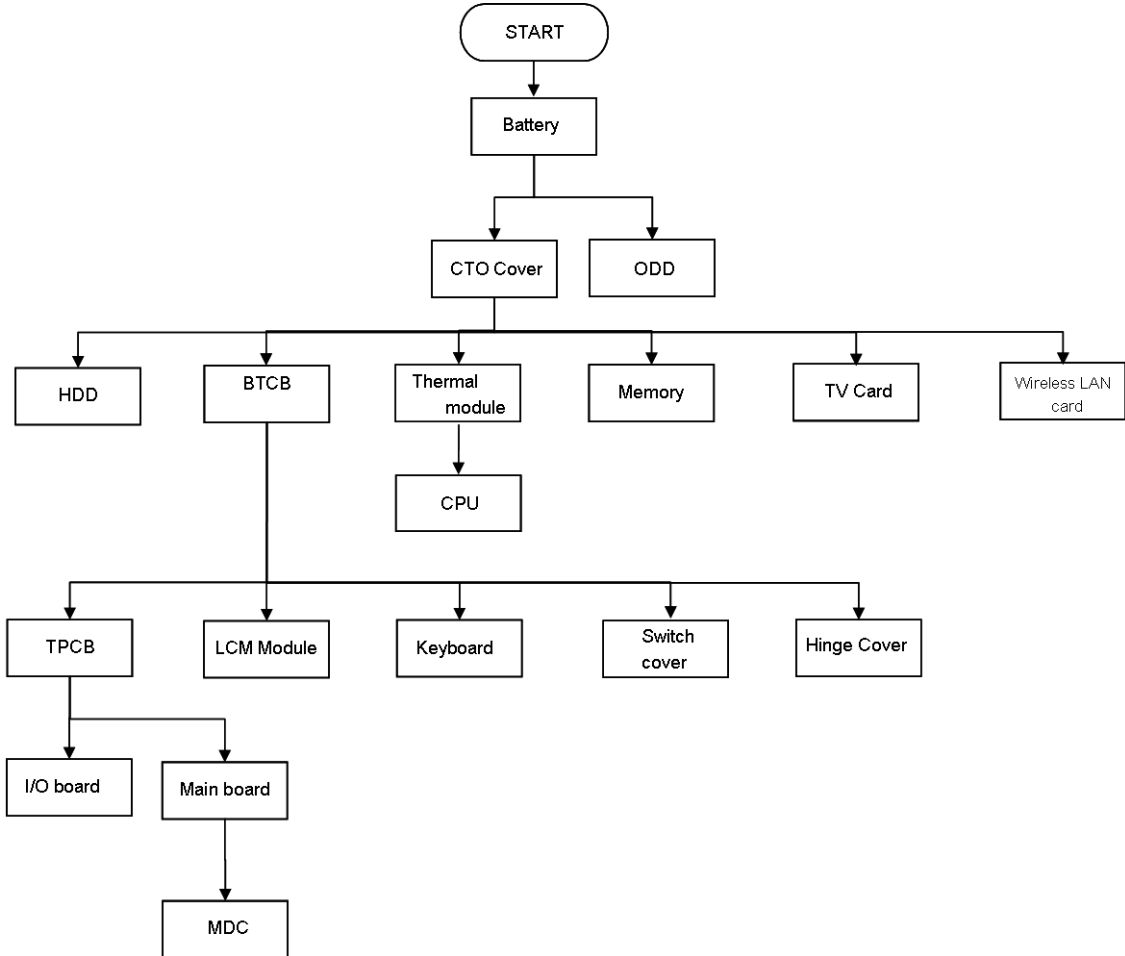

LCM module disassembly flow chart

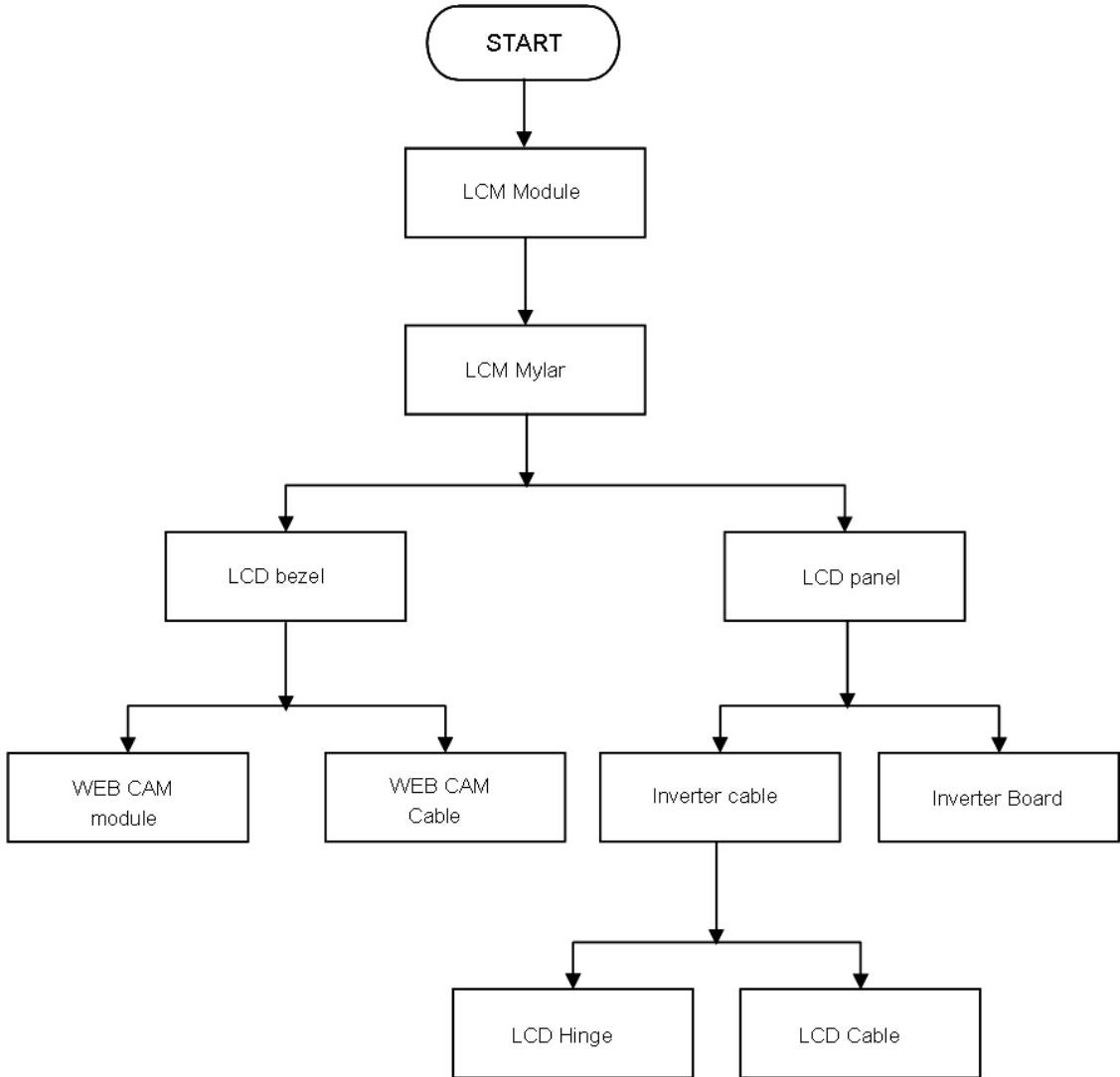

Removing the Battery Pack

1. Release the battery.
2. Slide the battery latch then remove the battery.



Removing the HDD/Memory Module/Wireless LAN Card/TV Tuner Card/System Fan/Thermal Modules/CPU

Removing the HDD

1. Remove the 7 screws fastening the CTO cover
2. Detach the CTO cover from the notebook.



Removing the Wireless Cover & RAM Module

3. Remove the wireless antenna and remove the wireless screws then remove the wireless card.
4. Pop out the memory module from the DIMM socket then remove it (If the notebook has two memory modules, then repeat this step).

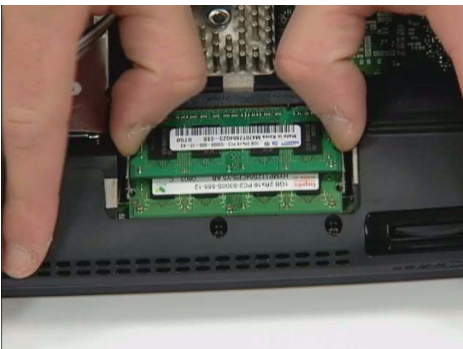

Removing the Wireless LAN Card/TV Tunder Card and System Fan

5. Disconnect the main and auxiliary antennae from the TV card.
6. Loose two screws from the TV card.
7. Remove the TV card from the machine.

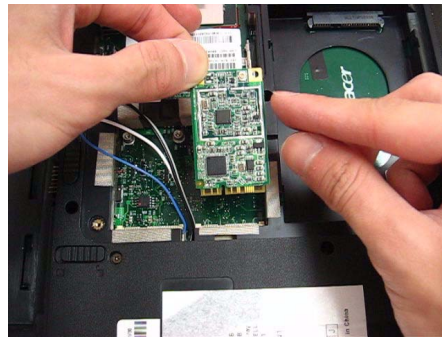

8. Remove HDD module as shown.

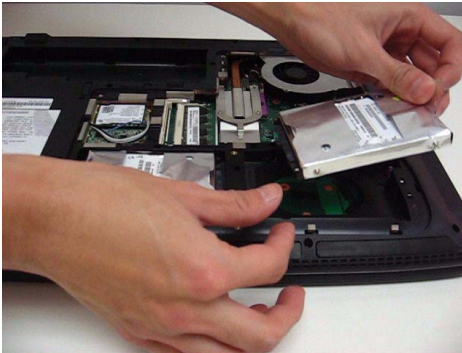

9. Remove FAN cable from the machine.
10. Loose the FAN screw.

11. Take out the system fan from the main unit as shown.

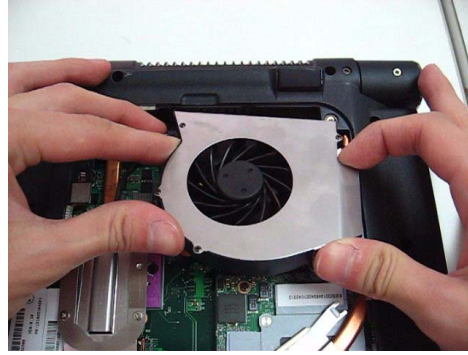
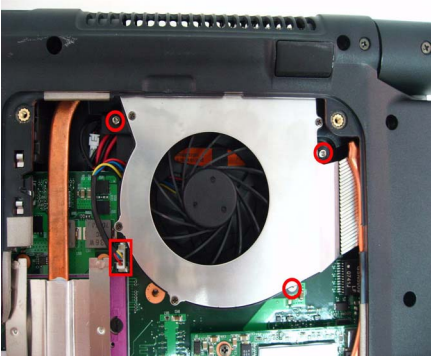

Removing the Thermal Modules and the CPU

12. Remove the two screws holding the finger heatsink.

13. Detach the finger heatsink from the main board.

14. Then take out the CPU heatsink from the main board.

15. Use a flat screwdriver to release the CPU lock (Turn counter clock-wise) then remove the CPU carefully.

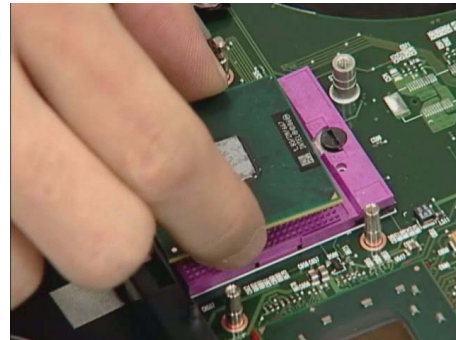
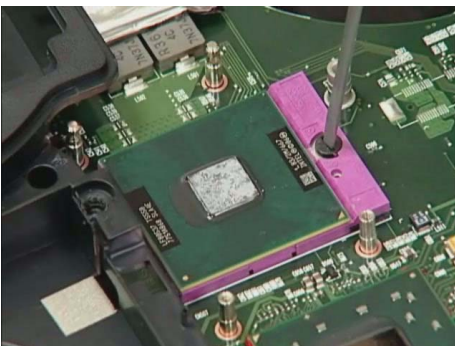
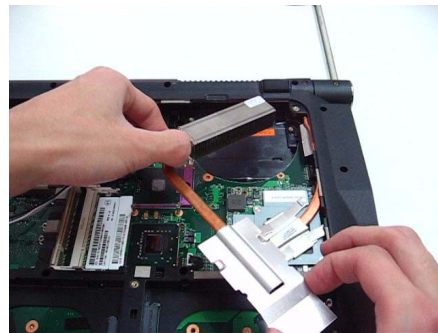
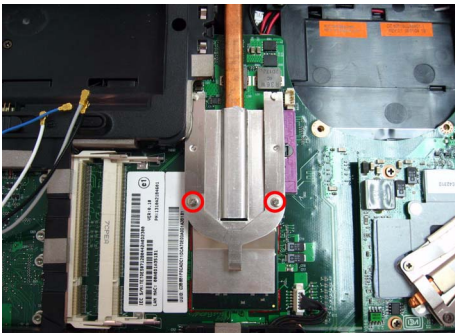

16. Remove the Express dummy card.

17. Remove the card reader dummy.



Removing the ODD

18. Remove the screw fastening the optical disk drive module on the bottom.

19. Use a tool to push the optical disk drive module outwards and remove the ODD module.



Removing the Hinge cover

20. Remove two hinge cover screws.

21. Then detach the Hinge cover from both side.



Removing the BTCB screws

22. Loose 31 screws from BTCB.



23. Detach Switch cover.

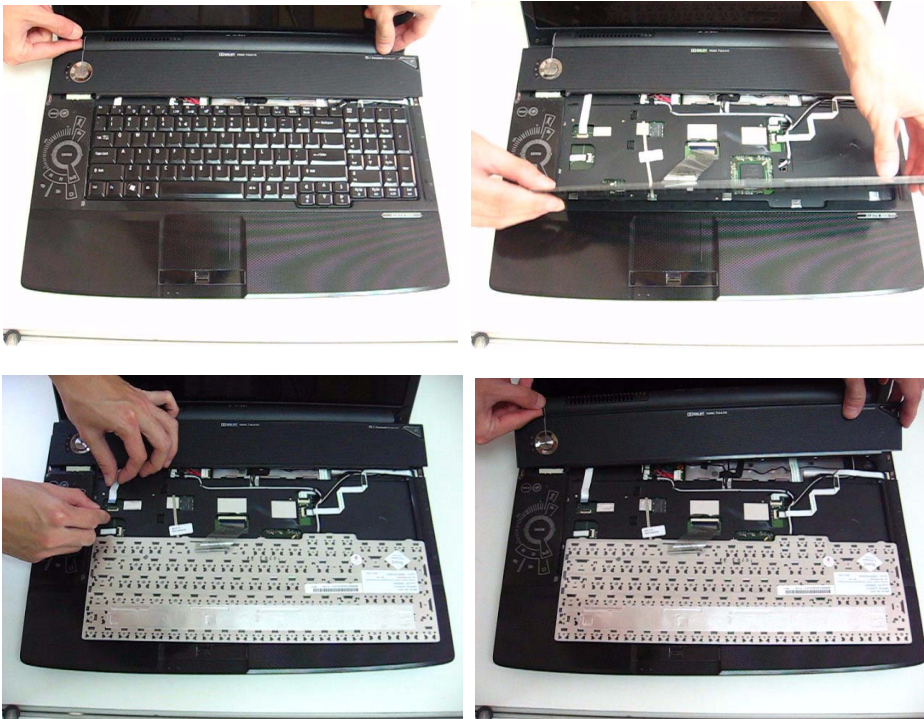

24. Disconnect Media board FFC from the Switch cover.

25. Then remove the switch cover from the machine.

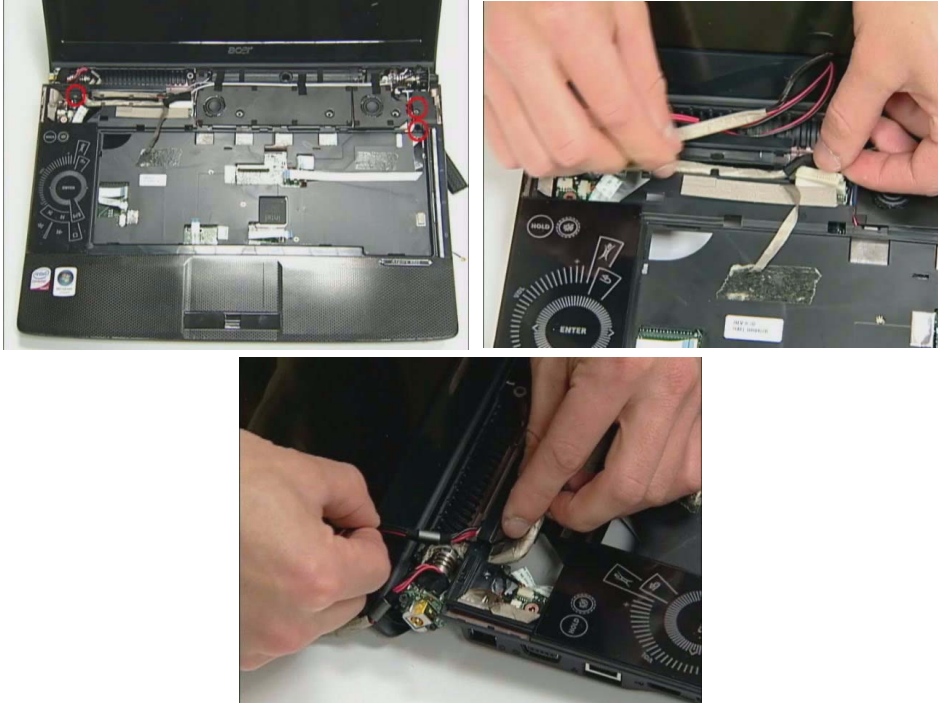

Disassembling the Main Unit

1. Turn over the keyboard as the image shows.
2. Disconnect the Keyboard FFC from the main board
3. Then remove the keyboard from the main unit.

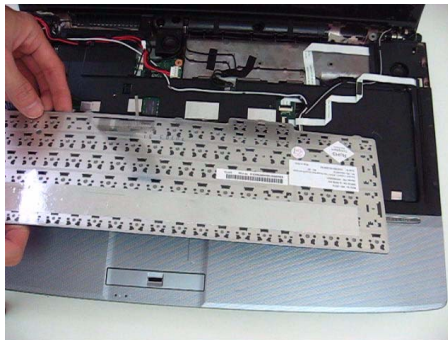
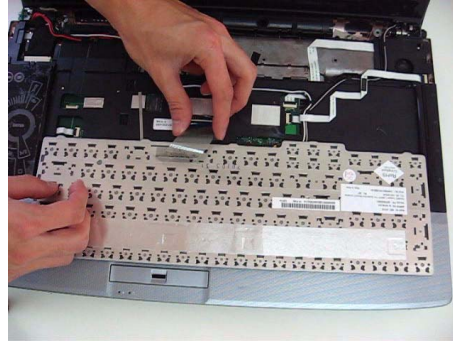
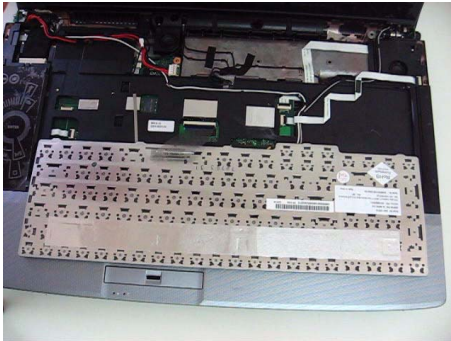

4. Disconnect the FFC from the main board.

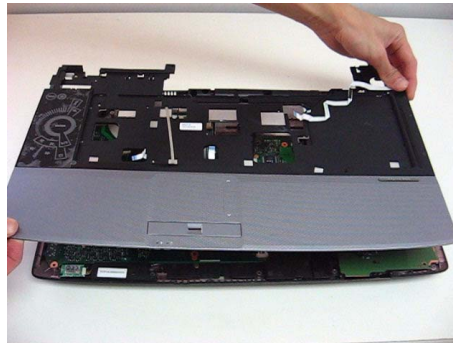
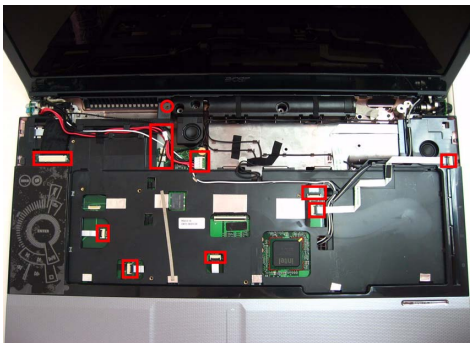

5. Loose One screws from the TPCB.
6. Disconnect the LCM cable.
7. Pull out the Power cable.
8. Pull out the Wireless antenna.
9. Release four TPCB locker then remove the TCB from machine.
10. Disassembling the LED boards.

11. Loose the LED boards four screws.

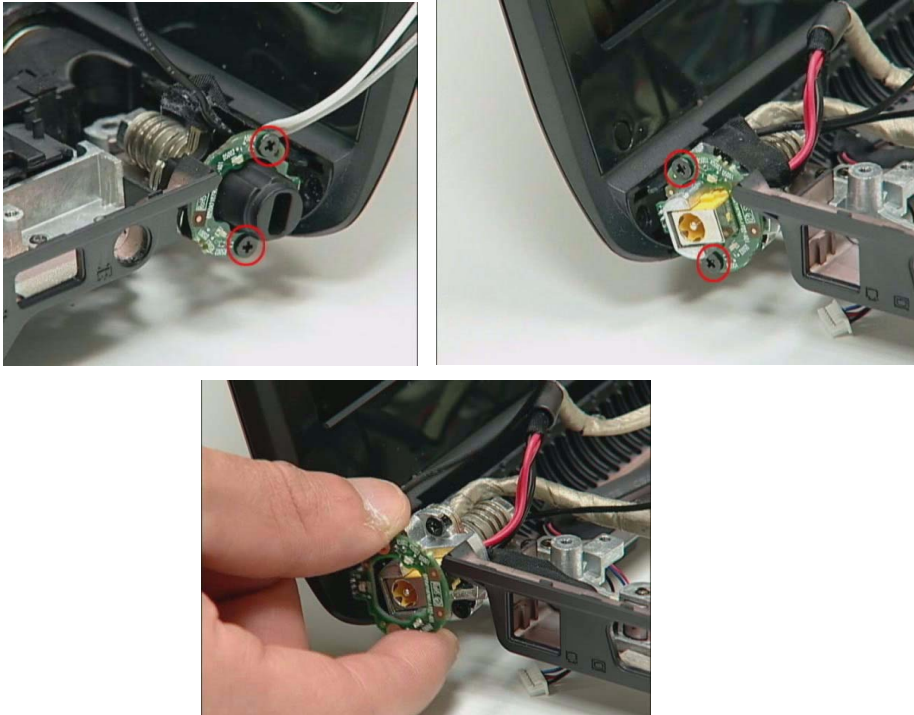

12. Loose four LCM hinge screws.

13. Then remove LCM module from the machine.



Remove I/O board and Main Board.

14. Remove the daughter board from the machine.
15. Loose two Modem card screws.

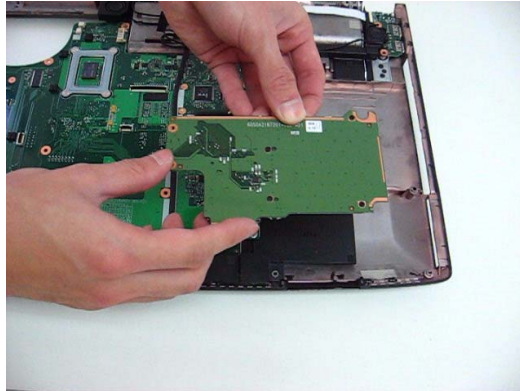

16. Disconnect Modem card cable.
17. Remove Modem card from the M/B.

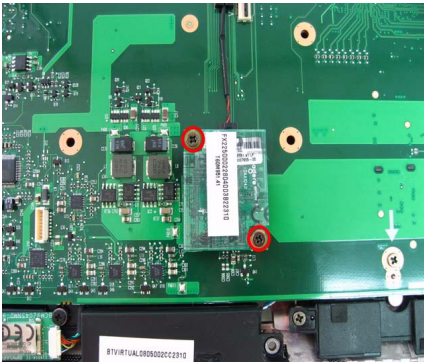

18. Disconnect Speaker cable from the MB and loose the MB screw.
19. Remove M/B from the BTCB.

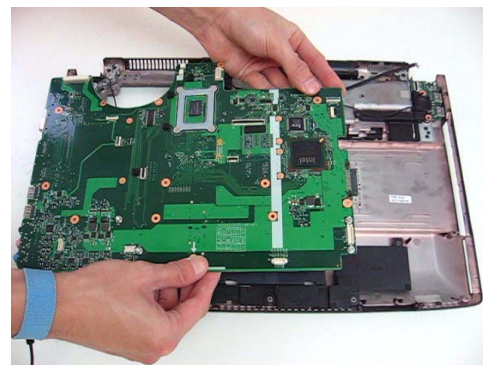
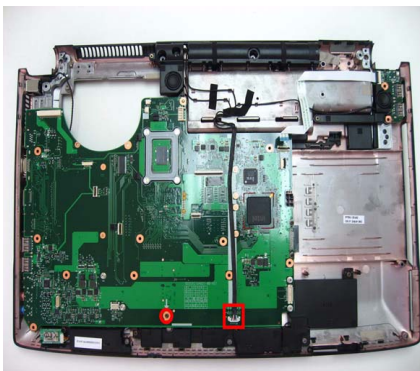

20. Remove RJ11 from the BTCB.

21. Remove the USB board from BTCB.

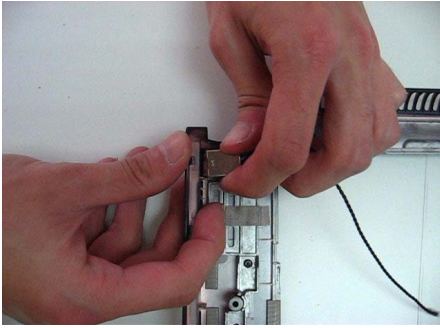

Disassembly LCM module

1. Remove six LCM bezel mylar.
2. Loose 10 LCM bezel screws.
3. Remove LCM bezel.



4. Disconnect Inverter cable and Back LED board cable.
5. Remove Inverter from BTCB.

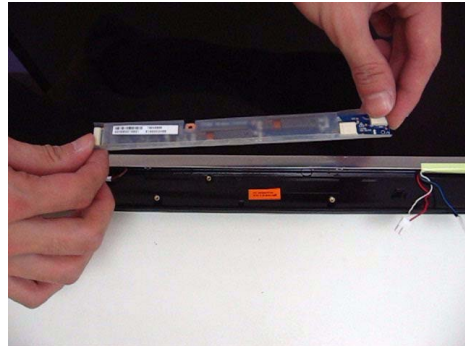

6. Loose four LCD screws from the hinge.
7. Disconnect CCD cable.
8. Remove the LCD panel.



-
9. Loosen four LCD hinge screws, then remove two hinges from LCD panel.

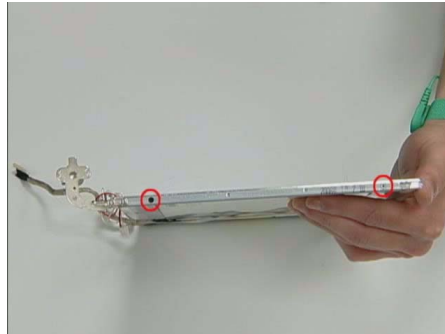

Disassembling the External Modules

Disassembling the HDD Module

1. Remove the four screws holding the HDD (hard disk drive) foil; two on each side.
2. Carefully take out the hard disk drive from the HDD foil.

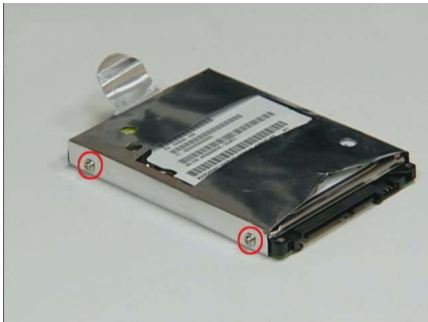

Disassembling the ODD Module

1. Remove the two screws holding the optical bracket.
2. Then remove the optical bracket from the optical disk drive.



Troubleshooting

Use the following procedure as a guide for computer problems.

NOTE: The diagnostic tests are intended to test only Acer products. Non-Acer products, prototype cards, or modified options can give false errors and invalid system responses.

1. Obtain the failing symptoms in as much detail as possible.
2. Verify the symptoms by attempting to re-create the failure by running the diagnostic test or by repeating the same operation.
3. Use the following table with the verified symptom to determine which page to go to.

Symptoms (Verified)	Go To
Power failure. (The power indicator does not go on or stay on.)	"Power System Check" on page 71.
POST does not complete. No beep or error codes are indicated.	"Power-On Self-Test (POST) Error Message" on page 73 "Undetermined Problems" on page 88
POST detects an error and displayed messages on screen.	"Error Message List" on page 74
Other symptoms (i.e. LCD display problems or others).	"Power-On Self-Test (POST) Error Message" on page 73
Symptoms cannot be re-created (intermittent problems).	Use the customer-reported symptoms and go to "Power-On Self-Test (POST) Error Message" on page 73 "Intermittent Problems" on page 87 "Undetermined Problems" on page 88

System Check Procedures

External Diskette Drive Check

Do the following to isolate the problem to a controller, driver, or diskette. A write-enabled, diagnostic diskette is required.

NOTE: Make sure that the diskette does not have more than one label attached to it. Multiple labels can cause damage to the drive or cause the drive to fail.

Do the following to select the test device.

1. Boot from the diagnostics diskette and start the diagnostics program.
2. See if FDD Test is passed as the program runs to FDD Test.
3. Follow the instructions in the message window.

If an error occurs with the internal diskette drive, reconnect the diskette connector on the system board.

If the error still remains:

1. Reconnect the external diskette drive/DVD-ROM module.
2. Replace the external diskette drive/CD-ROM module.
3. Replace the main board.

External CD-ROM Drive Check

Do the following to isolate the problem to a controller, drive, or CD-ROM. Make sure that the CD-ROM does not have any label attached to it. The label can cause damage to the drive or can cause the drive to fail.

Do the following to select the test device:

1. Boot from the diagnostics diskette and start the diagnostics program.
2. See if CD-ROM Test is passed when the program runs to CD-ROM Test.
3. Follow the instructions in the message window.

If an error occurs, reconnect the connector on the System board. If the error still remains:

1. Reconnect the external diskette drive/CD-ROM module.
2. Replace the external diskette drive/CD-ROM module.
3. Replace the main board.

Keyboard or Auxiliary Input Device Check

Remove the external keyboard if the internal keyboard is to be tested.

If the internal keyboard does not work or an unexpected character appears, make sure that the flexible cable extending from the keyboard is correctly seated in the connector on the system board.

If the keyboard cable connection is correct, run the Keyboard Test.

If the tests detect a keyboard problem, do the following one at a time to correct the problem. Do not replace a non-defective FRU:

1. Reconnect the keyboard cables.
2. Replace the keyboard.
3. Replace the main board.

The following auxiliary input devices are supported by this computer:

- Numeric keypad
- External keyboard

If any of these devices do not work, reconnect the cable connector and repeat the failing operation.

Memory check

Memory errors might stop system operations, show error messages on the screen, or hang the system.

1. Boot from the diagnostics diskette and start the doagmpstotics program (please refer to main board).
2. Go to the diagnostic memory in the test items.
3. Press F2 in the test items.
4. Follow the instructions in the message window.

NOTE: Make sure that the DIMM is fully installed into the connector. A loose connection can cause an error.

Power System Check

To verify the symptom of the problem, power on the computer using each of the following power sources:

1. Remove the battery pack.
2. Connect the power adapter and check that power is supplied.
3. Disconnect the power adapter and install the charged battery pack; then check that power is supplied by the battery pack.

If you suspect a power problem, see the appropriate power supply check in the following list:

- “Check the Power Adapter” on page 71
- “Check the Battery Pack” on page 71

Check the Power Adapter

Unplug the power adapter cable from the computer and measure the output voltage at the plug of the power adapter cable. See the following figure

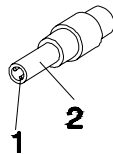

Pin 1: +19 to +20.5V
Pin 2: 0V, Ground

1. If the voltage is not correct, replace the power adapter.
2. If the voltage is within the range, do the following:
 - Replace the System board.
 - If the problem is not corrected, see “Undetermined Problems” on page 88.
 - If the voltage is not correct, go to the next step.

NOTE: An audible noise from the power adapter does not always indicate a defect.

3. If the power-on indicator does not light up, check the power cord of the power adapter for correct continuity and installation.
4. If the operational charge does not work, see “Check the Battery Pack” on page 71.

Check the Battery Pack

To check the battery pack, do the following:

From Software:

1. Check out the Power Management in control Panel
2. In Power Meter, confirm that if the parameters shown in the screen for Current Power Source and Total Battery Power Remaining are correct.
3. Repeat the steps 1 and 2, for both battery and adapter.
4. This helps you identify first the problem is on recharging or discharging.

From Hardware:

1. Power off the computer.
2. Remove the battery pack and measure the voltage between battery terminals 1(+) and 6(ground). See the following figure

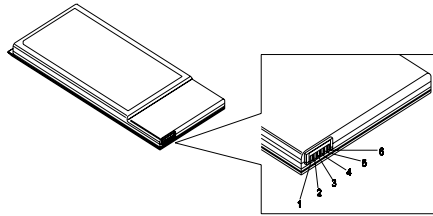

3. If the voltage is still less than 7.5 Vdc after recharging, replace the battery.

To check the battery charge operation, use a discharged battery pack or a battery pack that has less than 50% of the total power remaining when installed in the computer.

If the battery status indicator does not light up, remove the battery pack and let it return to room temperature. Re-install the battery pack.

If the charge indicator still does not light up, replace the battery pack. If the charge indicator still does not light up, replace the DC/DC charger board.

Touchpad Check

If the touchpad doesn't work, do the following actions one at a time to correct the problem. Do not replace a non-defective FRU:

1. Reconnect the touchpad cables.
2. Replace the touchpad.
3. Replace the system board.

After you use the touchpad, the pointer drifts on the screen for a short time. This self-acting pointer movement can occur when a slight, steady pressure is applied to the touchpad pointer. This symptom is not a hardware problem. No service actions are necessary if the pointer movement stops in a short period of time.

Power-On Self-Test (POST) Error Message

The POST error message index lists the error message and their possible causes. The most likely cause is listed first.

NOTE: Perform the FRU replacement or actions in the sequence shown in FRU/Action column, if the FRU replacement does not solve the problem, put the original part back in the computer. Do not replace a non-defective FRU.

This index can also help you determine the next possible FRU to be replaced when servicing a computer.

If the symptom is not listed, see “Undetermined Problems” on page 88.

The following lists the error messages that the BIOS displays on the screen and the error symptoms classified by function.

NOTE: Most of the error messages occur during POST. Some of them display information about a hardware device, e.g., the amount of memory installed. Others may indicate a problem with a device, such as the way it has been configured.

NOTE: If the system fails after you make changes in the BIOS Setup Utility menus, reset the computer, enter Setup and install Setup defaults or correct the error.

Index of Error Messages

Error Code List

Error Codes	Error Messages
006	Equipment Configuration Error Causes: 1. CPU BIOS Update Code Mismatch 2. IDE Primary Channel Master Drive Error (The causes will be shown before "Equipment Configuration Error")
010	Memory Error at xxxx:xxxx:xxxxh (R:xxxxh, W:xxxxh)
070	Real Time Clock Error
071	CMOS Battery Bad
072	CMOS Checksum Error
110	System disabled. Incorrect password is specified.
<No error code>	Battery critical LOW In this situation BIOS will issue 4 short beeps then shut down system, no message will show.
<No error code>	Thermal critical High In this situation BIOS will shut down system, not show message.

Error Message List

Error Messages	FRU/Action in Sequence
Failure Fixed Disk	Reconnect hard disk drive connector. "Load Default Settings" in BIOS Setup Utility. Hard disk drive System board
Stuck Key	see "Keyboard or Auxiliary Input Device Check" on page 70.
Keyboard error	see "Keyboard or Auxiliary Input Device Check" on page 70.
Keyboard Controller Failed	see "Keyboard or Auxiliary Input Device Check" on page 70.
Keyboard locked - Unlock key switch	Unlock external keyboard
Monitor type does not match CMOS - Run Setup	Run "Load Default Settings" in BIOS Setup Utility.
Shadow RAM Failed at offset: nnnn	BIOS ROM System board
System RAM Failed at offset: nnnn	DIMM System board
Extended RAM Failed at offset: nnnn	DIMM System board
System battery is dead - Replace and run Setup	Replace RTC battery and Run BIOS Setup Utility to reconfigure system time, then reboot system.

Error Messages	FRU/Action in Sequence
System CMOS checksum bad - Default configuration used	RTC battery Run BIOS Setup Utility to reconfigure system time, then reboot system.
System timer error	RTC battery Run BIOS Setup Utility to reconfigure system time, then reboot system. System board
Real time clock error	RTC battery Run BIOS Setup Utility to reconfigure system time, then reboot system. System board
Previous boot incomplete - Default configuration used	Run "Load Default Settings" in BIOS Setup Utility. RTC battery System board
Memory size found by POST differed from CMOS	Run "Load Default Settings" in BIOS Setup Utility. DIMM System board
Diskette drive A error	Check the drive is defined with the proper diskette type in BIOS Setup Utility See "External Diskette Drive Check" on page 70.
Incorrect Drive A type - run SETUP	Check the drive is defined with the proper diskette type in BIOS Setup Utility
System cache error - Cache disabled	System board
CPU ID:	System board
DMA Test Failed	DIMM System board
Software NMI Failed	DIMM System board
Fail-Safe Timer NMI Failed	DIMM System board
Device Address Conflict	Run "Load Default Settings" in BIOS Setup Utility. RTC battery System board
Allocation Error for device	Run "Load Default Settings" in BIOS Setup Utility. RTC battery System board
Failing Bits: nnnn	DIMM BIOS ROM System board
Fixed Disk n	None
Invalid System Configuration Data	BIOS ROM System board

Error Messages	FRU/Action in Sequence
I/O device IRQ conflict	Run "Load Default Settings" in BIOS Setup Utility. RTC battery System board
Operating system not found	Enter Setup and see if fixed disk and drive A: are properly identified. Diskette drive Hard disk drive System board

Error Message List

No beep Error Messages	FRU/Action in Sequence
No beep, power-on indicator turns off and LCD is blank.	Power source (battery pack and power adapter). See "Power System Check" on page 71. Ensure every connector is connected tightly and correctly. Reconnect the DIMM. LED board. System board.
No beep, power-on indicator turns on and LCD is blank.	Power source (battery pack and power adapter). See "Power System Check" on page 71. Reconnect the LCD connector Hard disk drive LCD inverter ID LCD cable LCD Inverter LCD System board
No beep, power-on indicator turns on and LCD is blank. But you can see POST on an external CRT.	Reconnect the LCD connectors. LCD inverter ID LCD cable LCD inverter LCD System board
No beep, power-on indicator turns on and a blinking cursor shown on LCD during POST.	Ensure every connector is connected tightly and correctly. System board
No beep during POST but system runs correctly.	Speaker System board

InsydeH2O Post Codes

Sec:

NO_EVICTION_MODE_DEBUG EQU 1 (CommonPlatform\sec\la32\SecCore.inc)

Code	POST Routine Description
0xC2	MTRR setup
0xC3	Enable cache
0xC4	Establish cache tags
0xC5	Enter NEM, Place the BSP in No Fill mode, set CR0.CD = 1, CR0.NW = 0
0xCF	Cache Init Finished

Memory:

DEBUG_BIOS EQU 1 (Chipset\Alviso\MemoryInitAsm\IA32\IMEMORY.INC)

Code	POST Routine Description
0xA0	First memory check point
0x01	Enable MCHBAR
0x02	Check for DRAM initialization interrupt and reset fail
0x03	Verify all DIMMs are DDR or DDR2 and unbuffered
0x04	Detect an improper warm reset and handle
0x05	Detect if ECC SO-DIMMs are present in the system
0x06	Verify all DIMMs are single or double sided and not asymmetric
0x07	Verify all DIMMs are x8 or x16 width
0x08	Find a common CAS latency between the DIMMS and the MCH
0x09	Determine the memory frequency and CAS latency to program
0x10	Determine the smallest common TRAS for all DIMMs
0x11	Determine the smallest common TRP for all DIMMs
0x12	Determine the smallest common TRCD for all DIMMs
0x13	Determine the smallest refresh period for all DIMMs
0x14	Verify burst length of 8 is supported by all DIMMs
0x15	Determine the smallest tWR supported by all DIMMs
0x16	Determine DIMM size parameters
0x17	Program the correct system memory frequency
0x18	Determine and set the mode of operation for the memory channels
0x19	Program clock crossing registers
0x20	Disable Fast Dispatch
0x21	Program the DRAM Row Attributes and DRAM Row Boundary registers
0x22	Program the DRAM Bank Architecture register
0x23	Program the DRAM Timing & and DRAM Control registers
0x24	Program ODT
0x25	Perform steps required before memory init
0x26	Program the receive enable reference timing control register Program the DLL Timing Control Registers , RCOMP settings
0x27	Enable DRAM Channel I/O Buffers

Code	POST Routine Description
0x28	Enable all clocks on populated rows
0x29	Perform JEDEC memory initialization for all memory rows
0x30	Perform steps required after memory init
0x31	Program DRAM throttling and throttling event registers
0x32	Setup DRAM control register for normal operation and enable
0x33	Enable RCOMP
0x34	Clear DRAM initialization bit in the SB
0x35	Initialization Sequence Completed, program graphic clocks
0xAF	Disable access to the XMM registers

BDS & Specific action:

Code	POST Routine Description
0x00	Report the legacy boot is happening
0x12	Wake up the APs
0x13	Initialize SMM Private Data and relocate BSP SMBASE
0x21	PC init begin at the stage1
0x27	Report every memory range do the hard ware ECC init
0x28	Report status code of every memory range
0x50	Get the root bridge handle
0x51	Notify pci bus driver starts to program the resource
0x58	Reset the host controller
0x5A	IdeBus begin initialization
0x70	Simple Text Output Protocol Functions(VGA class reset)
0x71	Report that VGA Class driver is being disabled
0x72	Report that VGA Class driver is being enabled
0x78	Terminal Console In reset and Console Out reset
0x79	Report that the remote terminal is being disabled
0x7A	Report that the remote terminal is being enabled
0x90	Keyboard reset
0x91	USB Keyboard disable
0x92	Keyboard detection
0x93	Report that the usb keyboard is being enabled
0x94	Clear the keyboard buffer
0x95	Init Keyboard
0x98	Mouse reset
0x99	Mouse disable
0x9A	Detect PS2 mouse
0x9B	Report that the mouse is being enabled
0xB8	Peripheral removable media reset(ex:lsafloppy, USB device)
0xB9	Peripheral removable media disable
0xBB	Peripheral removable media enable
0xE4	Report Status Code here for DXE_ENTRY_POINT once it is available
0xF8	Report that ExitBootServices() has been called

Code	POST Routine Description
0xF9	Runtime driver set virtual address map

Each PEIM entry point used in 80_PORT:

Code	POST Routine Description
0x00	
0x01	PEI_EVENT_LOG
0x02	PEI_OEM_SERVICE
0x03	PEI_SIO_INIT
0x04	PEI_MONO_STATUS_CODE
0x05	PEI_CPU_IO_PCI_CFG
0x06	PEI_CPU_IO
0x07	PEI_PCI_CFG
0x08	PEI_CPU_PEIM
0x09	PEI_PLATFORM_STAGE1
0x0A	PEI_VARIABLE
0x0B	PEI_SB_INIT
0x0C	PEI_CAPSULE
0x0D	PEI_PLATFORM_STAGE2
0x0E	PEI_SB_SMBUS_ARP_DISABLED
0x0F	PEI_HOST_TO_SYSTEM
0x10	PEI_MEMORY_INIT
0x11	PEI_S3_RESUME
0x12	PEI_CLOCK_GEN
0x13	PEI_OP_PRESENCE
0x14	PEI_TPM_TCG
0x15	PEI_FIND_FV
0x16	PEI_H2O_DEBUG_IO
0x17	PEI_H2O_DEBUG_COMM
0x18	PEI_SMM_CONTROL
0x19~0x1F	PEI_RESERVED
0x20~0x2E	PEI_OEM_DEFINED
0x2F	PEI_DXE_IPL

Each Driver entry point used in 80_PORT:

Code	POST Routine Description
0x30	RESERVED
0x31	DXE_CRC32_SECTION_EXTRACT
0x32	SCRIPT_SAVE
0x33	ACPI_S3_SAVE
0x34	SMART_TIMER
0x35	JPEG_DECODER
0x36	PCX_DECODER
0x37	HT_CPU / MP_CPU

Code	POST Routine Description
0x38	LEGACY_METRONOME
0x39	FTWLITE
0x3A	RUN_RIME
0x3B	MONOTONIC_COUNTER
0x3C	WATCH_DOG_TIMER
0x3D	SECURITY_STUB
0x3E	DXE_CPU_IO
0x3F	CF9_RESET
0x40	PC_RTC
0x41	STATUS_CODE
0x42	VARIABLE
0x43	EMU_VARIABLE
0x44	DXE_CHIPSET_INIT
0x45	DXE_ALERT_FORMAT
0x46	PCI_HOST_BRIDGE
0x47	PCI_EXPRESS
0x48	DXE_SB_INIT
0x49	IDE_CONTROLLER
0x4A	SATA_CONTROLLER
0x4B	SB_SM_BUS
0x4C	ISA_ACPI_DRIVER
0x4D	ISA_BUS
0x4E	ISA_SERIAL
0x4F	IDE_BUS
0x50	PCI_BUS
0x51	BOOT_PRIORITY
0x52	FVB_SERVICE
0x53	ACPI_PLATFORM
0x54	PCI_HOT_PLUG
0x55	DXE_PLATFORM
0x56	PLATFORM_IDE
0x57	SMBIOS
0x58	MEMORY_SUB_CLASS
0x59	MISC_SUB_CLASS
0x5A	CON_PLATFORM
0x5B	SAVE_MEMORY_CONFIG
0x5C	ACPI_SUPPORT
0x5D	CON_SPLITTER_UGA_VGA / CON_SPLITTER
0x5E	VGA_CLASS
0x5F	DATA_HUB
0x60	DISK_IO
0x61	MEMORY_TEST
0x62	CRISIS_RECOVERY

Code	POST Routine Description
0x63	LEGACY_8259
0x64	LEGACY_REGION
0x65	LEGACY_INTERRUPT
0x66	BIOS_KEYBOARD
0x67	BIOS_VEDIO
0x68	MONITER_KEY
0x69	LEGACY_BIOS
0x6A	LEGACY_BIOS_PLATFORM
0x6B	PCI_PLATFORM
0x6C	ISA_FLOOPY
0x6D	PS2_MOUSE
0x6E	USB_BOT
0x6F	USB_CBI0
0x70	USB_CBI1
0x71	USB_KB
0x72	USB_MASS_STORAGE
0x73	BUS_PCI_UHCI
0x74	USB_MOUSE
0x75	USB_BUS
0x76	SETUP_UTILITY
0x77	FW_BLOCK_SERVICE
0x78	USB_LEGACY_PLATFORM
0x79	GRAPHICS_CONSOLE
0x7A	TERMINAL
0x7B	DATA_HUB_STD_ERR
0x7C	FAT
0x7D	PARTITION
0x7E	ENGLISH
0x7F	FRENCH
0x80	HII_DATABASE
0x81	SETUP_BROWSER
0x82	OEM_SETUP_BROWSER
0x83	OEM_BADGING_SUPPORT
0x84	LEGACY_MOUSE
0x85	BIOS_SNP16
0x86	BUS_PCI_UNDI
0x87	SETUP_MOUSE
0x88	OEM_SETTING
0x89	MONITOR_KEY
0x8A	PLATFORM_BDS
0x8B	FAULT_TOLERANT_WRITE
0x8C	UPDATE_DISPATCHER
0x8D	CHINESE

Code	POST Routine Description
0x8E	TPM_S3_Resume
0x8F	USB_EHCI
0x90	SNP_32_64
0x91	PXE_BC
0x92	PXE_DHCP4
0x93	EBC
0x94~0x9F	RESERVED
0xA0	DXE_H2O_DEBUG_IO
0xA1	DXE_H2O_DEBUG_IO
0xA2	DXE_TPM_TCG
0xA3	DXE_TPM_PHYSICAL_PRESENCE
0xA4	DXE_OEM_SERVICE
0xA5	DXE_EVENT_LOG
0xA6	DXE_SECURITY_HDD_PASSWORD_SERVICE
0xA7	DXE_LAN_ASF_INIT
0xA8	DXE_BUS_PCI_SERIAL
0xA9	DXE_LAN_IDER_CONTROLLER
0xAA	DXE_LAN_AMT
0xAB	DXE_SECURITY_SYSTEM_PASSWORD_SERVICE
0xAC	DXE_SECURITY_PASSWORD_CONSOLE
0xAD	DXE_DATA_HUB_RECORD_POLICY
0xAE	DXE_TPM_DRIVER
0xAF	RESERVED
0xB0	JAPANESE
0xB1	DXE_UNICODE_COLLACTION

Each SmmDriver entry point used in 80_PORT:

Code	POST Routine Description
0xC0	SMM_ACCESS
0xC1	SMM_CONTROL
0xC2	SMM_BASE
0xC3	SMMAP
0xC4	SMMCORE
0xC5	SMM_DISPATCH
0xC6	SMM_START
0xC7	SMM_RUNTIME
0xC8	SB_SMM_DISPATCH
0xC9	SMM_THUNK
0xCA	SMM_ACPI_SW_CHILD
0xCB	SMM_SB_S3_SAVE
0xCC	SMM_PLATFORM
0xCD	SMM_GMCH_MBI
0xCE	SMM_FW_BLOCK_SERVICE

Code	POST Routine Description
0xCF	SMM_VARIABLE
0xD0	SMM_IHISI
0xD1	SMM_INT15_MICROCODE
0xD2	SMM_PNP
0xD3	SMM_USB_LEGACY
0xD4	SMM_INT13_HDD
0xD5	SMM_INIT_PPM
0xD6	SMM_OHCI1394
0xD7	SMM_SECURITY_HDD_PASSWORD_SERVICE
0xD8	SMM_OEM_SERVICE
0xD9	SMM_PPM
0xDA	SMM_DIGITAL_THERMAL_SENSOR

Index of Symptom-to-FRU Error Message

LCD-Related Symptoms

Symptom / Error	Action in Sequence
LCD backlight doesn't work LCD is too dark LCD brightness cannot be adjusted LCD contrast cannot be adjusted	Enter BIOS Utility to execute "Load Setup Default Settings", then reboot system. Reconnect the LCD connectors. Keyboard (if contrast and brightness function key doesn't work). LCD inverter ID LCD cable LCD inverter LCD System board
Unreadable LCD screen Missing pels in characters Abnormal screen Wrong color displayed	Reconnect the LCD connector LCD inverter ID LCD cable LCD inverter LCD System board
LCD has extra horizontal or vertical lines displayed.	LCD inverter ID LCD inverter LCD cable LCD System board

Indicator-Related Symptoms

Symptom / Error	Action in Sequence
Indicator incorrectly remains off or on, but system runs correctly	Reconnect the inverter board Inverter board System board

Power-Related Symptoms

Symptom / Error	Action in Sequence
Power shuts down during operation	Power source (battery pack and power adapter). See "Power System Check" on page 71. Battery pack Power adapter Hard drive & battery connection board System board
The system doesn't power-on.	Power source (battery pack and power adapter). See "Power System Check" on page 71. Battery pack Power adapter Hard drive & battery connection board System board

Symptom / Error	Action in Sequence
The system doesn't power-off.	Power source (battery pack and power adapter). See "Power System Check" on page 71. Hold and press the power switch for more than 4 seconds. System board
Battery can't be charged	See "Check the Battery Pack" on page 71. Battery pack System board

PCMCIA-Related Symptoms

Symptom / Error	Action in Sequence
System cannot detect the PC Card (PCMCIA)	PCMCIA slot assembly System board
PCMCIA slot pin is damaged.	PCMCIA slot assembly

Memory-Related Symptoms

Symptom / Error	Action in Sequence
Memory count (size) appears different from actual size.	Enter BIOS Setup Utility to execute "Load Default Settings, then reboot system. DIMM System board

Speaker-Related Symptoms

Symptom / Error	Action in Sequence
In Windows, multimedia programs, no sound comes from the computer.	Audio driver Speaker System board
Internal speakers make noise or emit no sound.	Speaker System board

Power Management-Related Symptoms

Symptom / Error	Action in Sequence
The system will not enter hibernation	See "Save to Disk (S4)" on page 37 Keyboard (if control is from the keyboard) Hard disk drive System board
The system doesn't enter hibernation mode and four short beeps every minute.	Press Fn+0 and see if the computer enters hibernation mode. Touchpad Keyboard Hard disk connection board Hard disk drive System board

Symptom / Error	Action in Sequence
The system doesn't enter standby mode after closing the LCD	See "Save to Disk (S4)" on page 37. LCD cover switch System board
The system doesn't resume from hibernation mode.	See "Save to Disk (S4)" on page 37. Hard disk connection board Hard disk drive System board
The system doesn't resume from standby mode after opening the LCD.	See "Save to Disk (S4)" on page 37. LCD cover switch System board
Battery fuel gauge in Windows doesn't go higher than 90%.	Remove battery pack and let it cool for 2 hours. Refresh battery (continue use battery until power off, then charge battery). Battery pack System board
System hangs intermittently.	Reconnect hard disk/CD-ROM drives. Hard disk connection board System board

Peripheral-Related Symptoms

Symptom / Error	Action in Sequence
System configuration does not match the installed devices.	Enter BIOS Setup Utility to execute "Load Default Settings", then reboot system. Reconnect hard disk/CD-ROM/diskette drives.
External display does not work correctly.	Press Fn+F5, LCD/CRT/Both display switching System board
USB does not work correctly	System board
Print problems.	Ensure the "Parallel Port" in the "Onboard Devices Configuration" of BIOS Setup Utility is set to Enabled. Onboard Devices Configuration Run printer self-test. Printer driver Printer cable Printer System Board
Serial or parallel port device problems.	Ensure the "Serial Port" in the Devices Configuration" of BIOS Setup Utility is set to Enabled. Device driver Device cable Device System board

Keyboard/Touchpad-Related Symptoms

Symptom / Error	Action in Sequence
Keyboard (one or more keys) does not work.	Reconnect the keyboard cable. Keyboard System board
Touchpad does not work.	Reconnect touchpad cable. Touchpad board System board

Modem-Related Symptoms

Symptom / Error	Action in Sequence
Internal modem does not work correctly.	Modem phone port modem combo board System board

NOTE: If you cannot find a symptom or an error in this list and the problem remains, see “Undetermined Problems” on page 88.

Intermittent Problems

Intermittent system hang problems can be caused by a variety of reasons that have nothing to do with a hardware defect, such as: cosmic radiation, electrostatic discharge, or software errors. FRU replacement should be considered only when a recurring problem exists.

When analyzing an intermittent problem, do the following:

1. Run the advanced diagnostic test for the system board in loop mode at least 10 times.
2. If no error is detected, do not replace any FRU.
3. If any error is detected, replace the FRU. Rerun the test to verify that there are no more errors.

Undetermined Problems

The diagnostic problems does not identify which adapter or device failed, which installed devices are incorrect, whether a short circuit is suspected, or whether the system is inoperative.

Follow these procedures to isolate the failing FRU (do not isolate non-defective FRU).

NOTE: Verify that all attached devices are supported by the computer.

NOTE: Verify that the power supply being used at the time of the failure is operating correctly. (See “Power System Check” on page 71):

1. Power-off the computer.
2. Visually check them for damage. If any problems are found, replace the FRU.
3. Remove or disconnect all of the following devices:
 - Non-Acer devices
 - Printer, mouse, and other external devices
 - Battery pack
 - Hard disk drive
 - DIMM
 - CD-ROM/Diskette drive Module
 - PC Cards
4. Power-on the computer.
5. Determine if the problem has changed.
6. If the problem does not recur, reconnect the removed devices one at a time until you find the failing FRU.
7. If the problem remains, replace the following FRU one at a time. Do not replace a non-defective FRU:
 - System board
 - LCD assembly

Jumper and Connector Locations

Top View

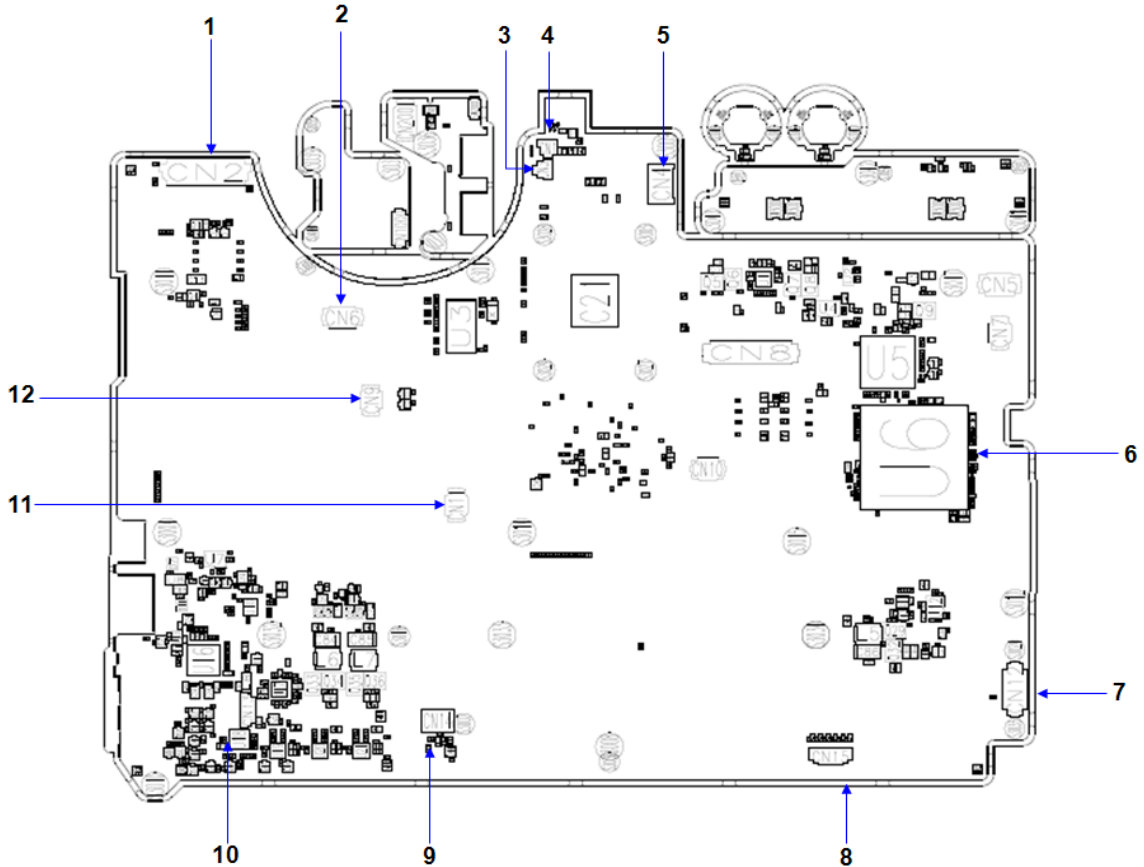

Aspire8930Q M/B layout and connector location TOP view		
No.	Name	Description
1	CN2	LCM Cable CNTR
2	CN6	Power Board FFC CNTR
3	CN3	LED Board Cable CNTR
4	CN1	LED Board Cable CNTR
5	CN4	Power Cable CNTR
6	U6	South Bridge
7	CN12	I/O Board CNTR
8	CN15	Speaker Cable CNTR
9	CN14	MDC CNTR
10	CN13	BT Cable CNTR
11	CN11	Touch Pad FFC CNTR
12	CN9	Media consle Board CNTR

Bottom View

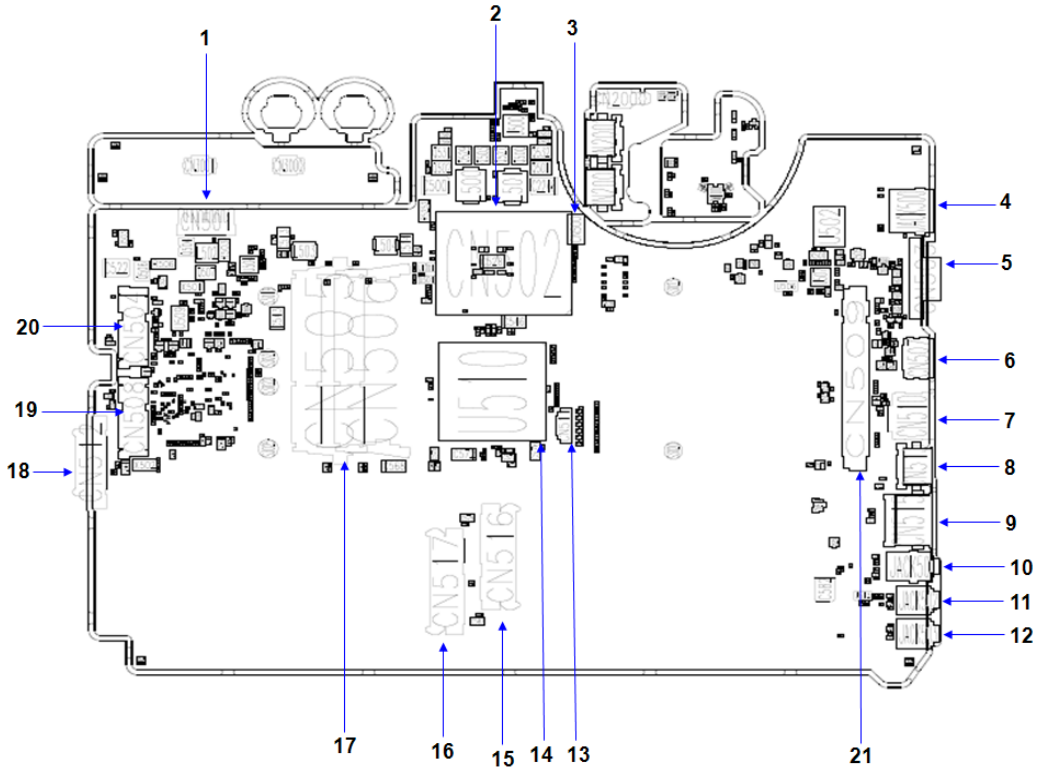

Bottom view		
No.	Name	Description
1	CN501	Battery CNTR
2	CN502	CPU Socket
3	CN500	FAN Cable CNTR
4	Jack500	RJ45
5	CN503	VGA Port
6	CN507	HDMI Port
7	CN510	HDMI Port
8	CN513	USB Port
9	CN515	USB Port
10	Jack501	SPDIF
11	Jack502	MIC jack
12	Jack503	Line in jack
13	CN511	Speaker Cable CNTR
14	U510	North Bridge
15	CN516	HDD Socket
16	CN517	HDD Socket
17	CN505/506	DIMM Socket
18	CN512	ODD CNTR
19	CN508	PCI-E Socket
20	CN504	PCI-E Socket
21	CN509	VGA Card Socket

FRU (Field Replaceable Unit) List

This chapter gives you the FRU (Field Replaceable Unit) listing in global configurations of Aspire 8930Q. Refer to this chapter whenever ordering for parts to repair or for RMA (Return Merchandise Authorization).

Please note that WHEN ORDERING FRU PARTS, you should check the most up-to-date information available on your regional web or channel. For whatever reasons a part number change is made, it will not be noted on the printed Service Guide. For ACER AUTHORIZED SERVICE PROVIDERS, your Acer office may have a DIFFERENT part number code from those given in the FRU list of this printed Service Guide. You MUST use the local FRU list provided by your regional Acer office to order FRU parts for repair and service of customer machines.

NOTE: To scrap or to return the defective parts, you should follow the local government ordinance or regulations on how to dispose it properly, or follow the rules set by your regional Acer office on how to return it.

Aspire 8930Q Exploded Diagram

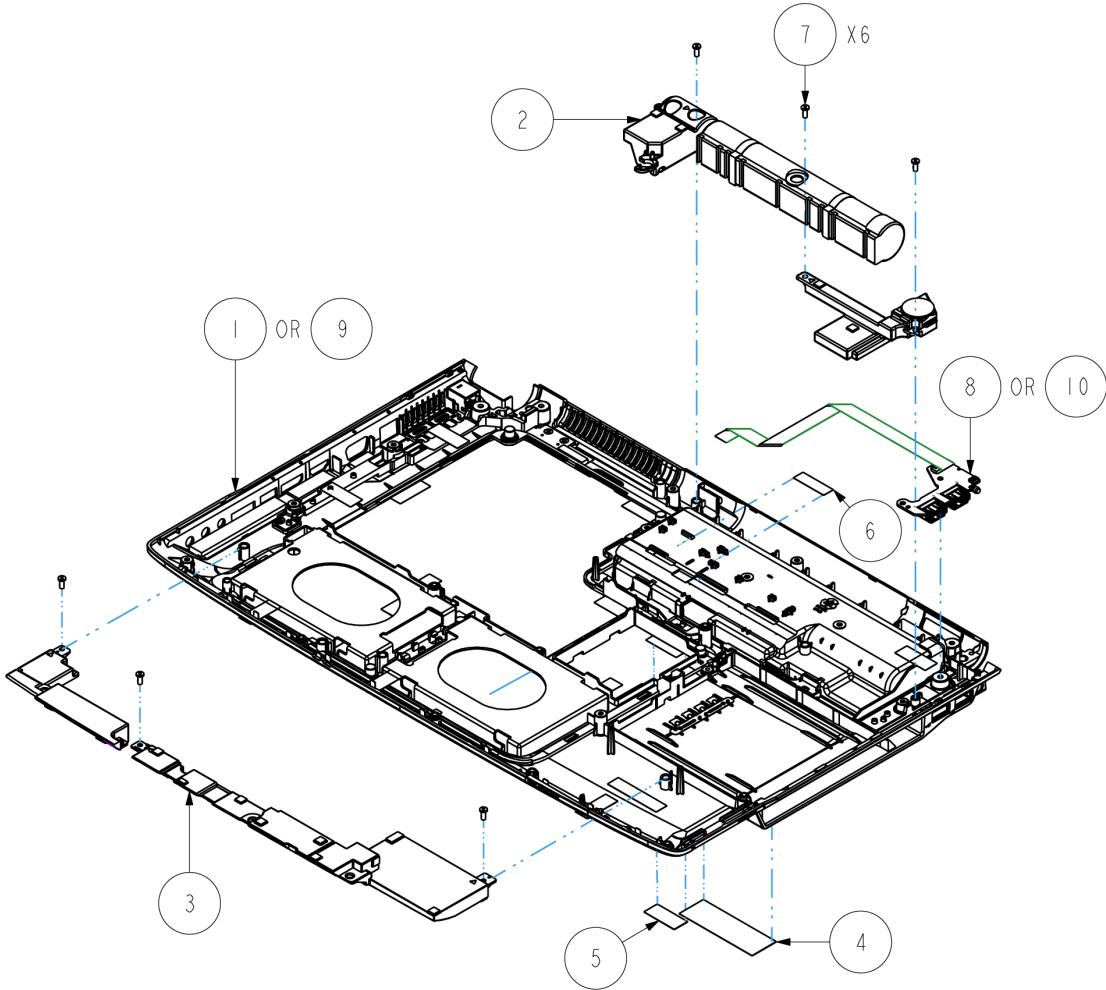

10		1397B0041101	ASSEMBLY, MODULE, USB		1
9		1510B0540102	ASSEMBLY, CASE, BOTTOM, SUB		1
8		1397B0041001	ASSEMBLY, MODULE, USB	1	1
7		6052B0078001	SCREW, 1, M2.5, 6.0mm, M, 4.5mm, 0.8mm, BNI, PATCH	6	6
6	CABLE MYLAR	6054A0076201	TAPE - 25x8x0.1mm - 3M8915	1	1
5		6060A0086501	LABEL, BLANK - 050 - 25x11	1	1
4		6060B0221401	LABEL, BLANK, REEL, 60mm, 20mm	1	1
3		6039B0023202	SPEAKER, SET, 40HM, 2W, 6, 21.8X21.8X4.8mm	1	1
2		6039B0023201	SPEAKER, SET, 40HM, 2W, 1041, 21.8X21.8X4.8mm	1	1
1		1510B0540101	ASSEMBLY, CASE, BOTTOM, SUB	1	
ITEM	PART NAME	PART NO	DESCRIPTION		01 02

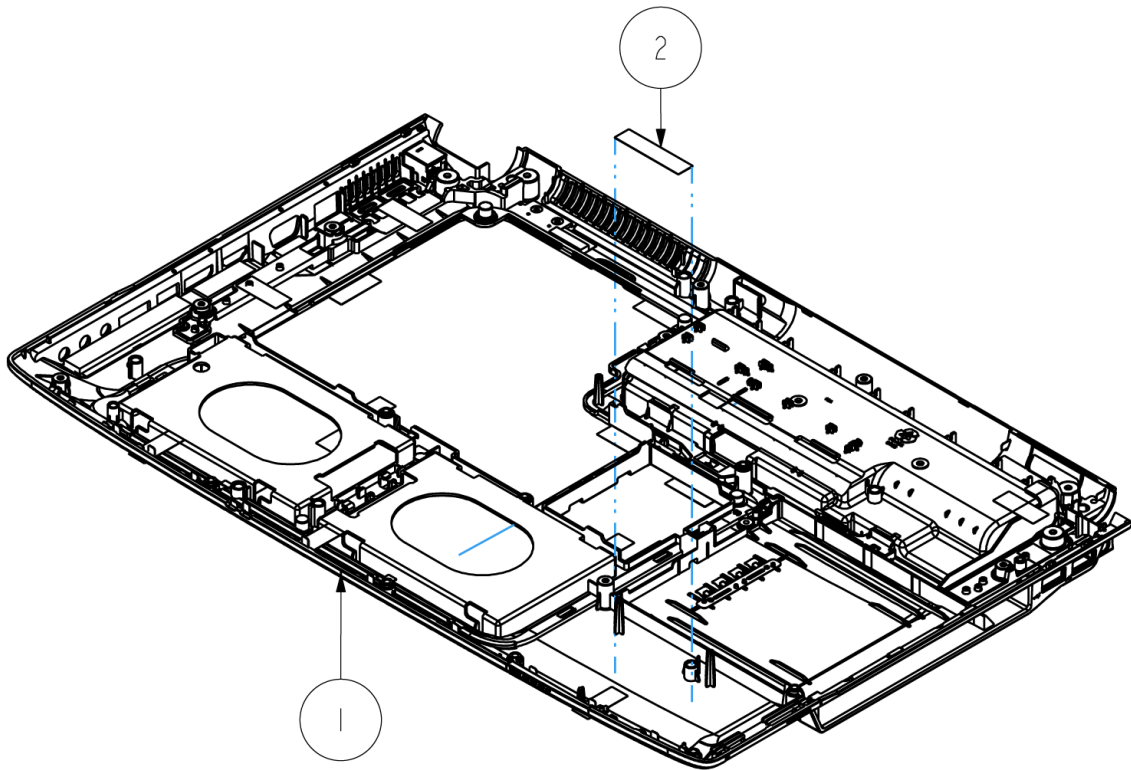

2		60600511J905	LABEL . BLANK - 033 - 40 * 9	1	1
1		1510B0540201	ASSEMBLY, CASE, BOTTOM, OFFLINE	1	1
ITEM	PART NAME	PART NO	DESCRIPTION	01	02

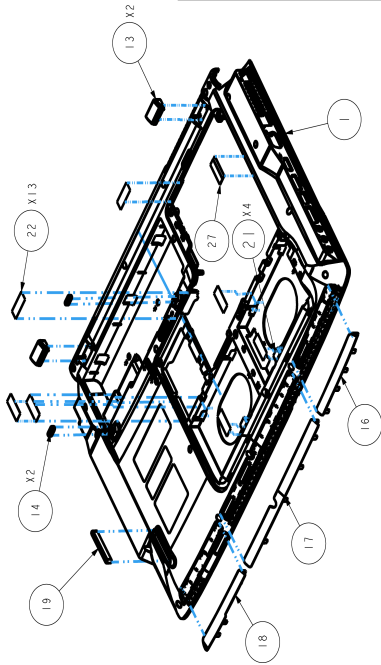

BOTTOM VIEW

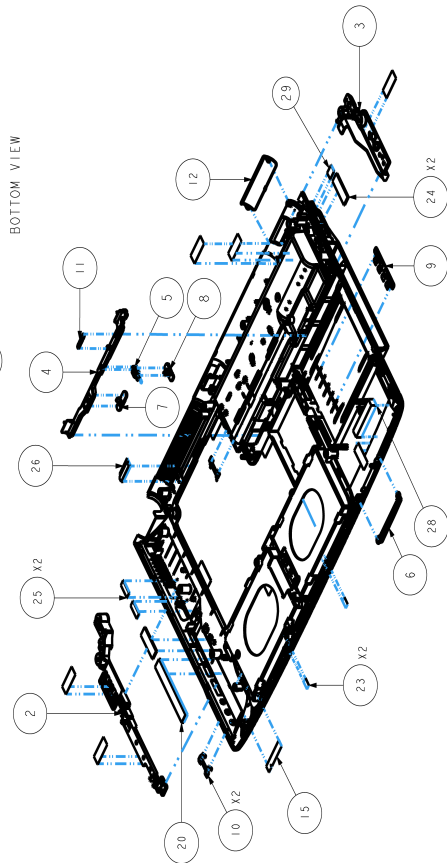

TOP VIEW

ITEM	PART NAME	PART NO	DESCRIPTION	QTY
29	CTO THERMAL GASKET	6054B0581120	GASKET, NI/CU PNW FOF, 8.0mm, 8.0mm, 0.5mm	1
28	BTM THERMAL GASKET	6054B0463201	GASKET, NI/CU PNW FOF, 40.0mm, 8.0mm, 7.0mm	1
27	BTM THERMAL GASKET	6054B05112401	GASKET, NI/CU PRS FR, 25.0mm, 11.0mm, 0.5mm	1
26	BTM THERMAL GASKET	6054B05811301	GASKET, BOTTOM THERMAL, NI/CU PNW FOF	1
25	BTM VGR GASKET	6054B0378901	GASKET, NI/CU PNW FOF, 16.0mm, 6.0mm, 1.0mm	2
24	CTO GASKET THERMAL	6054B0220201	GASKET, NI/CU PNW FOF, 30mm, 10mm, 1.5mm	2
23	BTM HDD GASKET	6054B0379101	GASKET, NI/CU PRS FR, 9.0mm, 5.0mm, 0.1mm	2
22	BTM TV-OUT GASKET	6054B0043601	GASKET, NI/CU PNW FOF, 10.0mm, 8.0mm, 0.6mm	4
20	BTM AUDIO GASKET	6054B0378801	GASKET, NI/CU PNW FOF, 70.0mm, 10.0mm, 3.0mm	1
19	BTM FRONT BUMPER	6054B0463001	FOOT, BOTTOM, FRONT, SILICONE	1
18	SPKR MESH R	6053B0345801	NET, BOTTOM, RIGHT, SPCC	1
17	SPKR MESH M	6053B0345901	NET, BOTTOM, MID, SPCC	1
16	SPKR MESH L	6053B0346001	NET, BOTTOM, LEFT, SPCC	1
15	BTM INSU BLUETOOTH	6054B0366301	INSULATOR, BOTTOM, BLUETOOTH, FR83	1
14	BTM BACK MID BUMPER	6054B0413701	FOOT, BOTTOM, BACK MID, SILICONE	2
13	BACK BUMPER	6051B0284401	FOOT, BOTTOM, PC+ABS+RUBBER	2
12	TUBE MESH	6053B0346101	NET, BOTTOM, TUBE, SPCC	1
11	BATTERY SPRING	6053B0345701	SPRING, EXTEN, BOTTOM, BATTERY, SUS304	1
10	BTM SHIELD	6053B0346201	SHIELD, BOTTOM, SUS301	2
9	BTM ODD SHIELD	6053B0346301	SHIELD, BOTTOM, ODD, SUS301	1
8	BATT KNOB LOCK	6051B0285001	KNOB, BATTERY, LOCK, PC+ABS	1
7	BATT KNOB	6051B0285101	KNOB, BATTERY, PC+ABS	1
6	IR BEZEL	6051B0284901	LENS, BOTTOM, IR, PC	1
5	BATT LATCH LOCK	6051B0285201	LATCH, BATTERY, LOCK, NYLON+30XGF	1
4	BATT LATCH	6051B0285301	LATCH, BATTERY, NYLON+30XGF	1
3	BRACKET RIGHT	6053B0403801	BASE, BOTTOM, RIGHT, MG ALLOY	1
2	BRACKET LEFT	6053B0403901	BASE, BOTTOM, LEFT, MG ALLOY	1
1	BTM CABINET	6051B0285502	CASE, BOTTOM, PC+ABS, PVD	1
	ITEM PART NAME	PART NO	DESCRIPTION	QTY

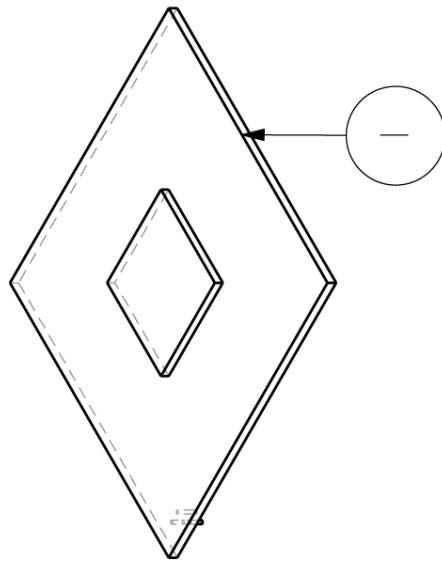

1		6025B0066903	CPU, 2.0GHZ, MICRO FCPGA, 478P, TRAY	1
ITEM	PART NAME	PART NO	DESCRIPTION	QTY
				01

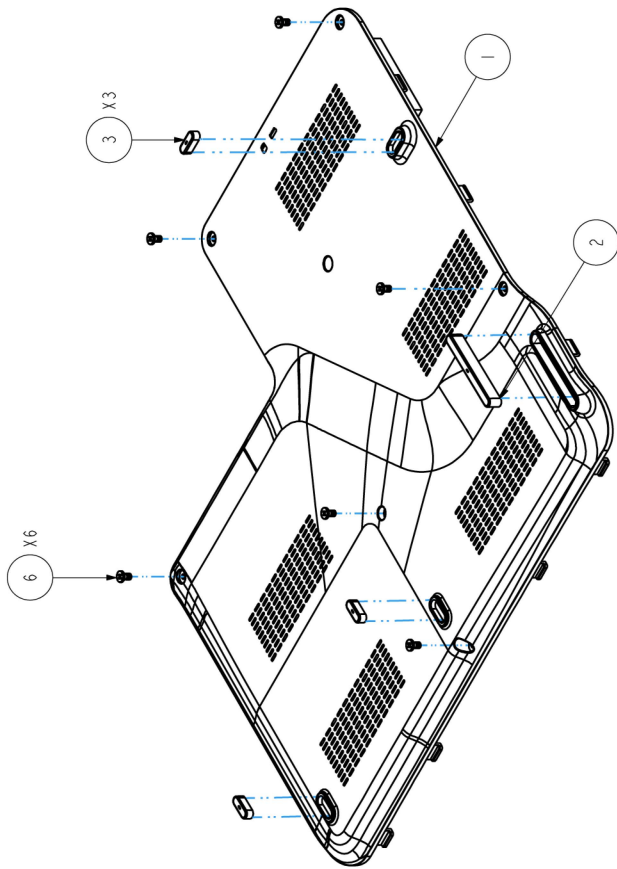

TOP VIEW

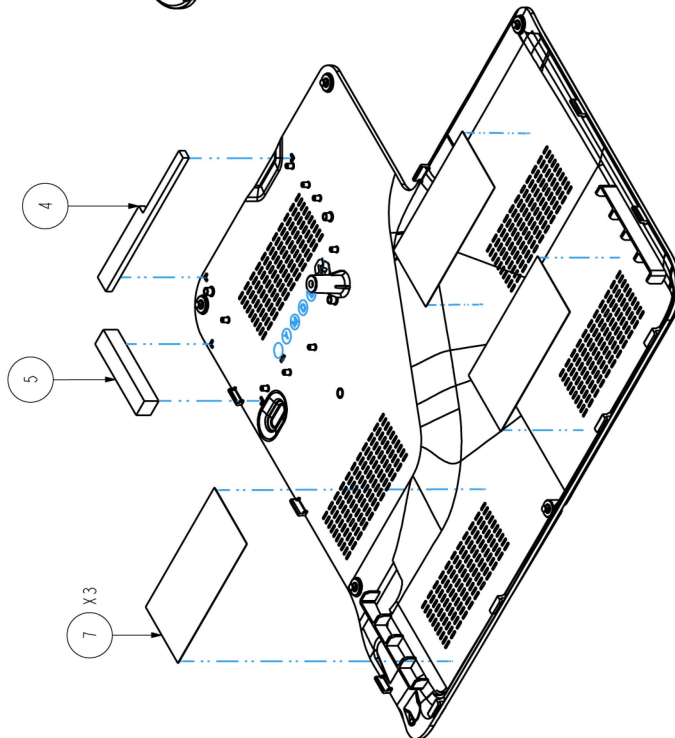

BOTTOM VIEW

7	CTO NET	6054B0352601	NET, CTO COVER, FR83	3
6	COVER SCREW	6052B0012301	SCREW, I, M2.5, 4mm, M, 4.5mm, 0.8mm, BNI, PATCH, C-RING	6
5	CTO THERMAL GASKET	6054B0463201	GASKET, NI/CU PINN FOF, 40.0mm, 8.0mm, 7.0mm	1
4	CTO FOAM RIGHT	6054B0366401	FOAM, CTO COVER, RIGHT, CR 4305	1
3	BTM BACK MID BUMPER	6054B0413701	FOOT, BOTTOM, BACK MID, SILICONE	3
2	BTM FRONT BUMPER	6054B0463001	FOOT, BOTTOM, FRONT, SILICONE	1
1	CTO COVER	6051B0357301	COVER, CTO, PC+ABS, PVD	1
ITEM	PART NAME	PART NO	DESCRIPTION	QTY

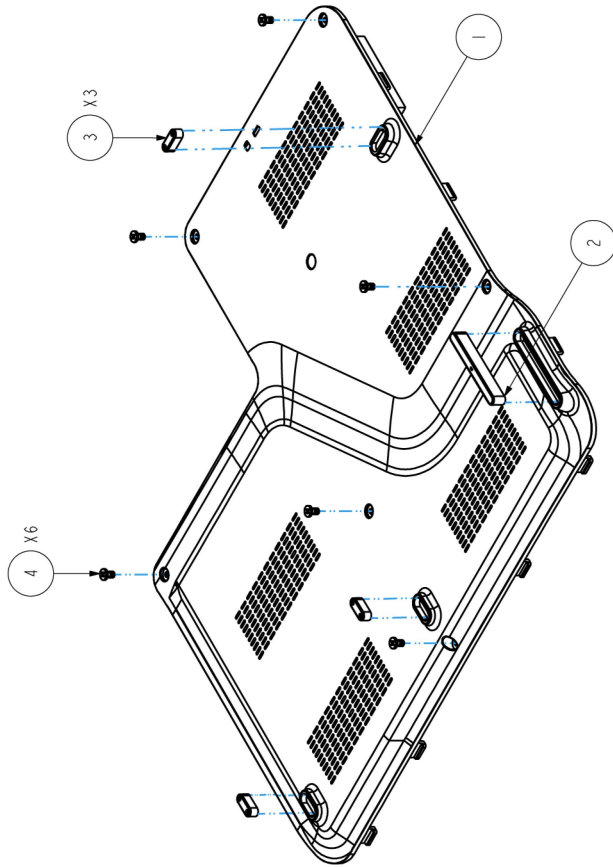

TOP VIEW

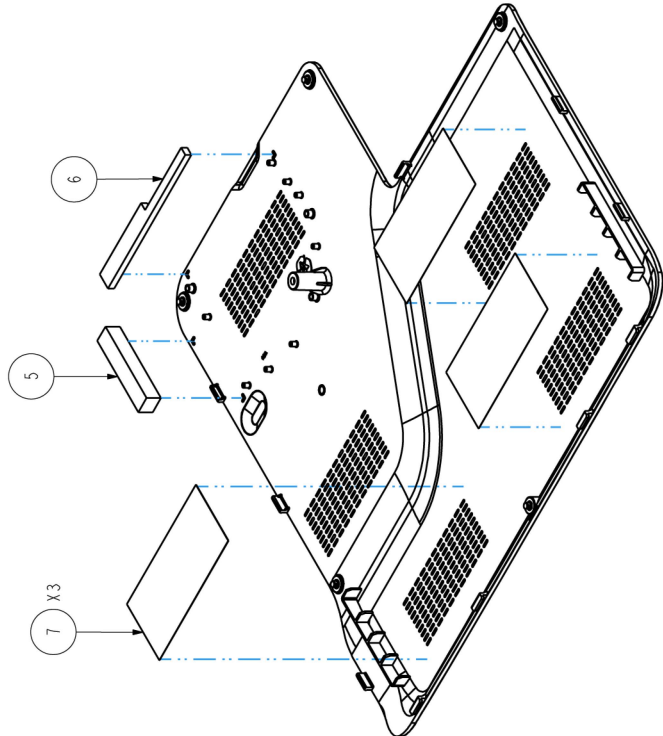

BOTTOM VIEW

ITEM	PART NAME	PART NO	DESCRIPTION	Q'TY
7	CTO NET	6054B035260	NET, CTO COVER, FR83	3
6	CTO FOAM RIGHT	6054B036640	FOAM, CTO COVER, RIGHT, CR 4305	1
5	CTO THERMAL GASKET	6054B046320	GASKET, NI/CU PNW FOF, 40.0mm, 8.0mm, 7.0mm	1
4	COVER SCREW	6052B001230	SCREW, I, M2.5, 4mm, M, 4.5mm, O, 8mm, BNI, PATCH, C-RING	6
3	BTM MID BUMPER	6054B046780	FOOT, BOTTOM, FRONT MID, SILICONE, THIN	3
2	BTM FRONT BUMPER	6054B046300	FOOT, BOTTOM, FRONT, SILICONE	1
1	CTO COVER	6051B028540	COVER, CTO, PC+ABS, PVD	1

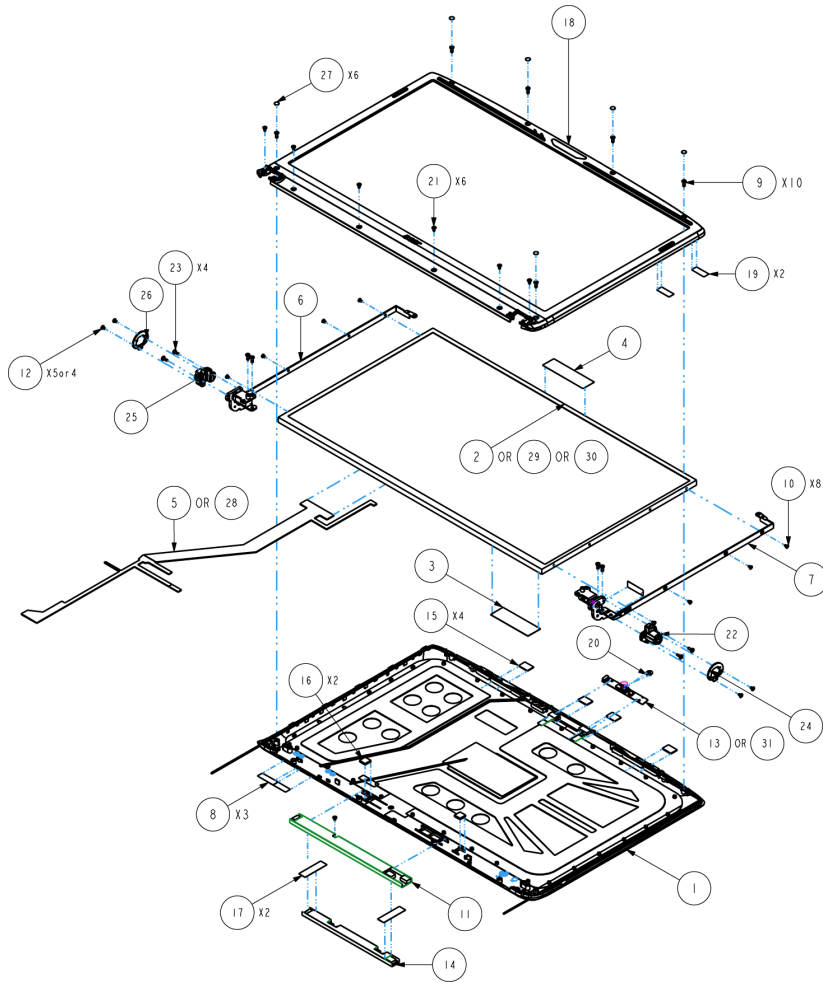

31	6047B000820	CAMERA MODULE, LENS, 1.0M			1			
30	6024B004480	LCM, 18.4, TFT, WUXGA, LVDS, 765g			1			
29	6024B004480	LCM, 18.4, TFT, WUXGA, LVDS, 765g		1				
28	6017B015830	CABLE, FLAT, 30POS, 380mm, 1, LCM		1	1			
27	DISP.CIRCLE.INSULATOR.	INSULATOR, DISPLAY, BEZEL, PC, CIRCLE	6	6	6			
26	1397B003430	ASSEMBLY, MODULE, LED		1	1	1		
25	6017B015840	CABLE, ROUND, 4POS, 200mm, 1, DC 1N		1	1	1		
24	1397B003440	ASSEMBLY, MODULE, LED		1	1	1		
23	6052B008070	SCREW, 1, M2, 6mm, M, 4.5mm, 0.8mm, PHIL, BK, PATCH	4	4	4			
22	HINGE.HENGLINGTON.BNT	BRACKET, HINGE COVER, RIGHT, ZN ALLOY		1	1	1		
21	SCREW 120040M	SCREW, 1, M2.0, 4mm, M, 4.5mm, 0.5mm, BNI, PATCH	6	6	6			
20	DISP.CCD.LENS.MYLAR	INSULATOR, DISPLAY, CCD, AS100, LENS		1	1	1		
19	INSU-8x20x0.11	INSU-PC6403-ST.POINT-01(MYLAR, 8*20*0.11)	2	2	2			
18	1510B046780	ASEMBLY, BEZEL, DISPLAY, OFFLINE		1	1	1		
17	TAPE 35x10x0.2T	TAPE, 35.0mm, 10.0mm, 0.2mm, 3M 8915			2			
16	6054B042290	FOAM, MO48, 9.0mm, 9.0mm, 2.0mm			2			
15	6054B042450	BUMPER, 14.0mm, 10.0mm, 1.0mm, SILICONE	4	4	4			
14	6038B001870	INVERTER, 9V-20V, AC710V, 56KHz, 141X11X3.9			1			
13	6047B000710	CAMERA MODULE, LENS, 0.3M		1	1	1		
12	SCREW 120030M	SCREW, 1, M2.0, 3.0mm, M, 4.5mm, .8mm, BNI, PATCH	5	5	4			
11	6038B001860	INVERTER, 9V-20V, AC800V, 56KHz, 180X15X3.9		1	1			
10	6052A000450	SCREW-120030M(4.0D*0.4T)-BK-PATCH	8	8	8			
9	6052B007800	SCREW, 1, M2.5, 6.0mm, M, 4.5mm, 0.8mm, BNI, PATCH	10	10	10			
8	CABLE.MYLAR	TAPE-25x8x0.1mm-3M8915		3	3	3		
7	6053B034800	HINGE-W BRACKET, DISPLAY, RIGHT, 13.0-14.6KGF-CM		1	1	1		
6	6053B034810	HINGE-W BRACKET, DISPLAY, LEFT, 13.0-14.6KGF-CM		1	1	1		
5	6017B015890	CABLE, FLAT, 30POS, 375mm, 1, LCM			1			
4	DISP.MYLAR	INSULATOR, DISPLAY, PANEL, AS100		1	1	1		
3	6060B022140	LABEL, BLANK, REEL, 60mm, 20mm		1	1	1		
2	SANSUNG-LTW1RAC101	LCM, 18.4, TFT, WXGA+, LVDS, 765g			1			
1	1510B046770	ASSEMBLY, CASE, REAR, DISPLAY, OFFLINE		1	1	1		
ITEM	PART NAME	PART NO	DESCRIPTION			01	02	03

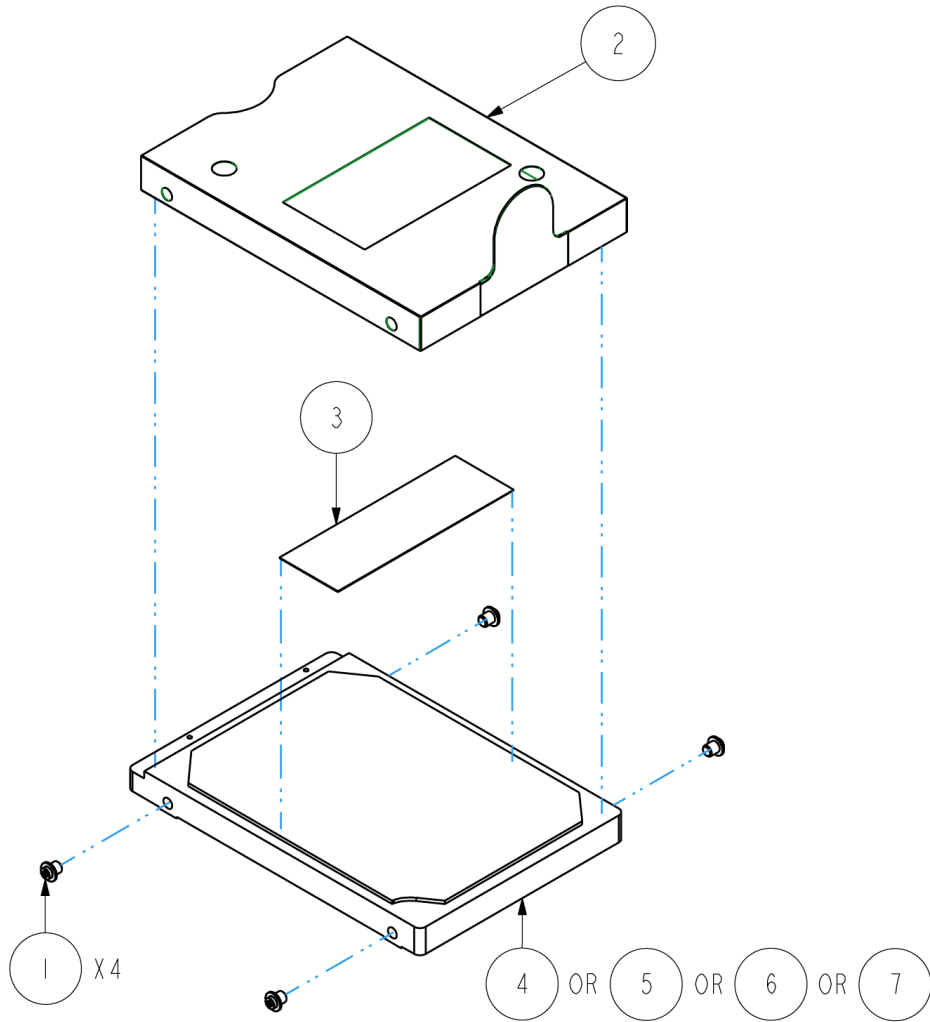

7		6022B0056802	HDD, SATA, 320GB, 5.4KRPM, 22P, 12ms, 5.5ms, SATA 2.0, 2.5X0.37, M3				1
6		6022B0056103	HDD, SATA, 250GB, 5.4KRPM, 22P, 12ms, 5.6ms, SATA 1.0, 2.5X0.37, M3			1	
5		6022B0068001	HDD, SATA, 160GB, 5.4KRPM, 22P, 12ms, 5.6ms, SATA 1.0, 2.5X0.37, M3		1		
4		6022B0056101	HDD, SATA, 120GB, 5.4KRPM, 22P, 12ms, 5.6ms, SATA 1.0, 2.5X0.37, M3	1			
3		6060B0221401	LABEL, BLANK, REEL, 60mm, 20mm	1	1	1	1
2	HDD_WYLAR	6054B0432201	INSULATOR, HDD, LUMIRROR S10+AL	1	1	1	1
1	SCREW-WI30030M(5.0Dx1.5T)-NI-HARDEN	6052A0029401	SCREW-WI30030M(5.0Dx1.5T)-NI-HARDEN	4	4	4	4
ITEM	PART NAME	PART NO	DESCRIPTION	01	02	03	04

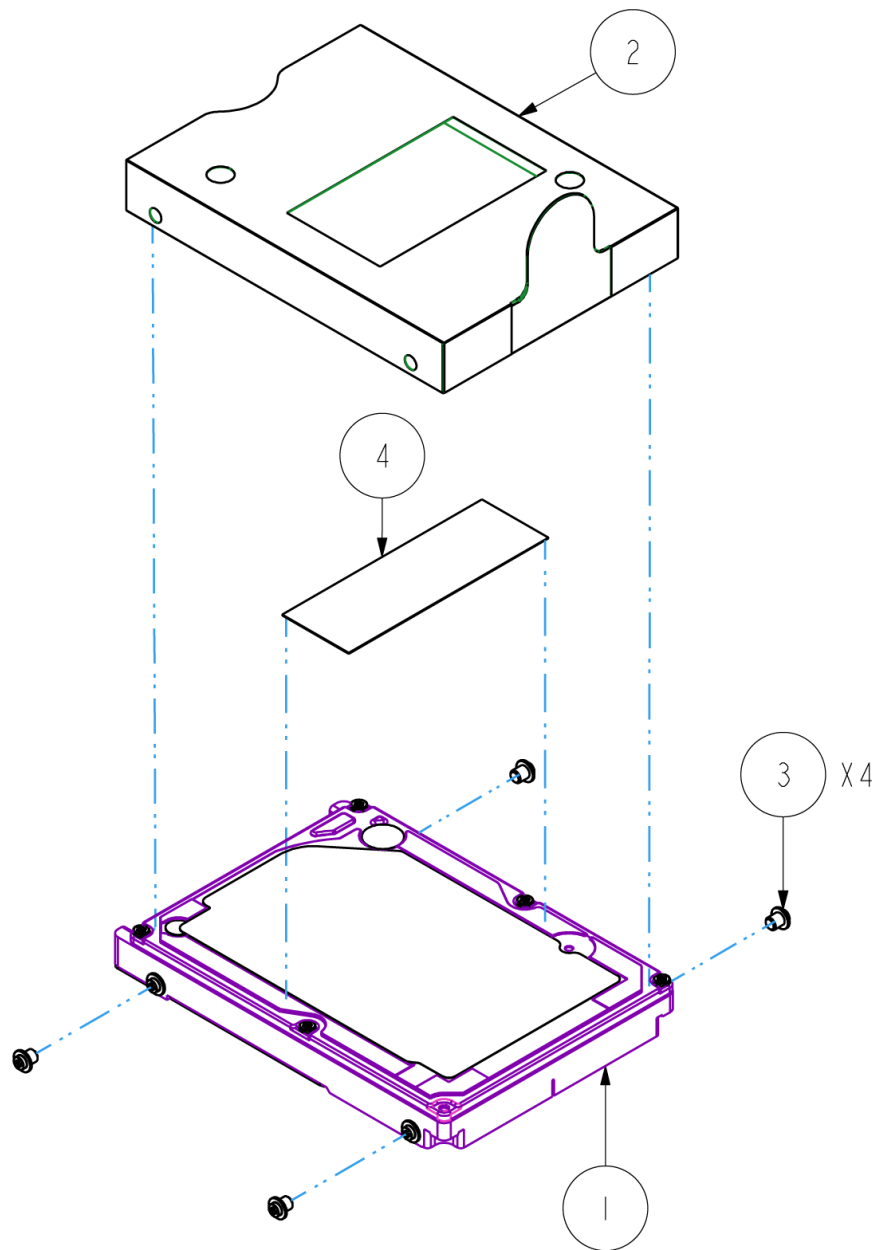

4		6060B0221401	LABEL, BLANK, REEL, 60mm, 20mm	1
3	SCREW-W130030M(5.0Dx1.5T)-NI-HARDEN	6052A0029401	SCREW-W130030M(5.0Dx1.5T)-NI-HARDEN	4
2	HDD_MYLAR	6054B0463101	INSULATOR, HDD, LUMIRROR SiO+AL, 12.5MM	1
1	HITACHI-HTS545050NTA300	6022B0065601	HDD, SATA, 500GB, 5.4KRPM, 22P, 12ms, 5.5ms, SATA 11, 2.5X0.49, M3	1
ITEM	PART NAME	PART NO	DESCRIPTION	Q'TY

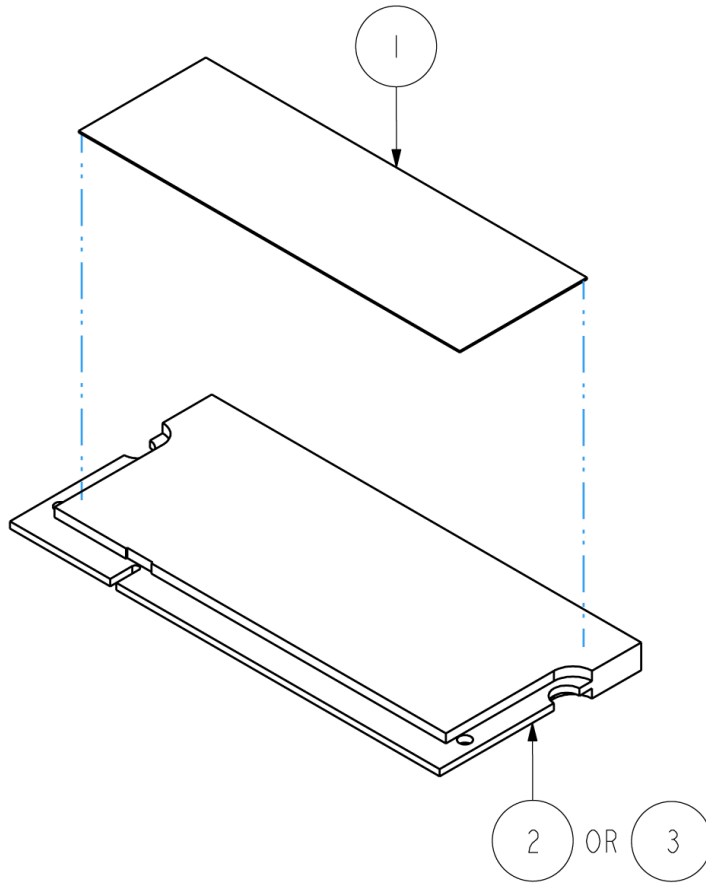

3		6021B0094601	MEMORY MODULE, 2GB, PC3-8500, DDR3, 204P, 256MX64, 0.15ns, 7, UB		1
2		6021B0094501	MEMORY MODULE, 1GB, PC3-8500, DDR3, 204P, 128MX64, 0.15ns, 7, UB	1	
1		6060B0221401	LABEL, BLANK, REEL, 60mm, 20mm	1	1
ITEM	PART NAME	PART NO	DESCRIPTION	01	02

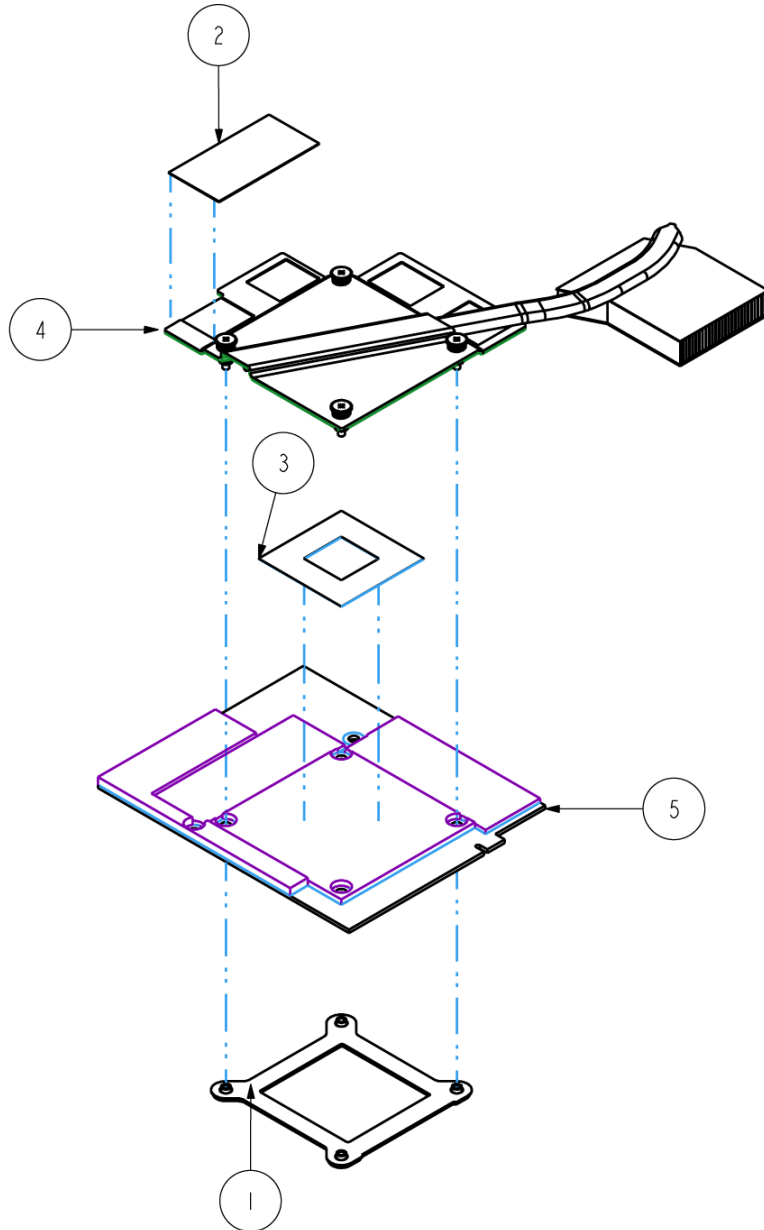

5		6042B009650	MODULE, MXM GRAPHICS, PCI-EXPRESS	1
4		6043B005570	THERMAL MODULE, 9EGE	1
3	MXM INSULATOR	6054B004010	INSULATOR, PCB, MXM, PC	1
2		6060B023850	LABEL, BLANK, REEL, 40mm, 20mm	1
1	BRACKET, BTM, MXM3, NV	6053B034820	BRACKET, BOTTOM NV, MXM3, SECC	1
ITEM	PART NAME	PART NO	DESCRIPTION	Q'TY

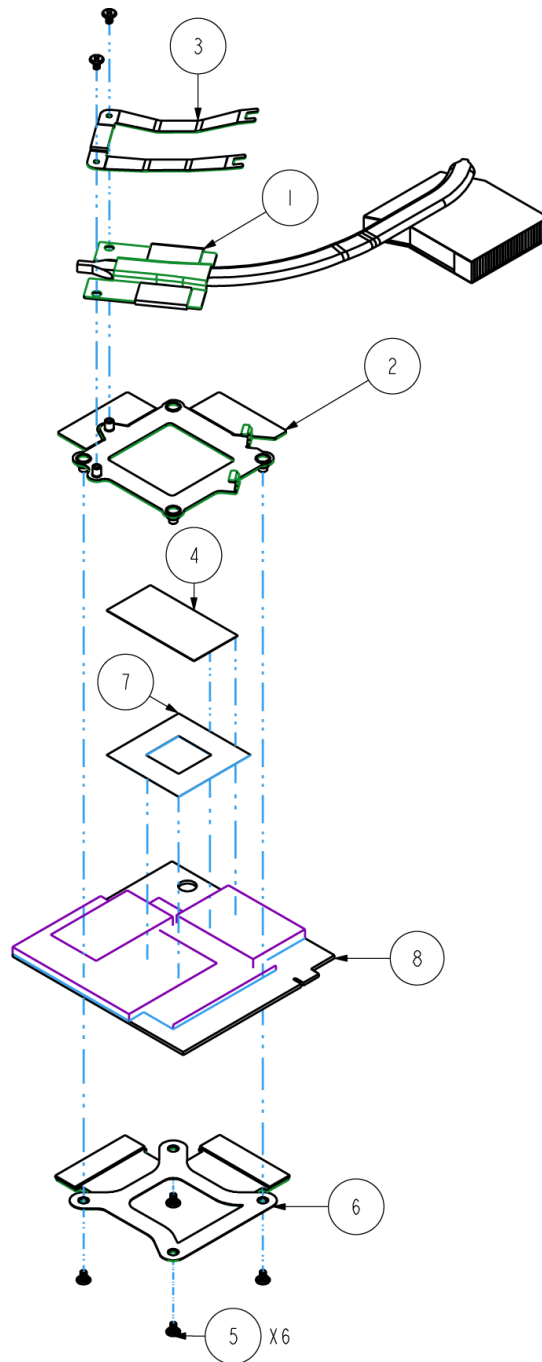

8		6042B0096101	MODULE, MXM GRAPHICS, PCI-EXPRESS	1
7	MXM INSULATOR	6054B0040101	INSULATOR, PCB, MXM, PC	1
6		6053B0227901	BRACKET, VGA, BOTTOM, SECC	1
5	SCREW I20030M45D8TBN1	6052B0012501	SCREW, 1, M2.0, 3.0mm, M, 4.5mm, .8mm, BNI, PATCH	6
4		6060B0238501	LABEL, BLANK, REEL, 40mm, 20mm	1
3	FINGER, GPU	6053B0346601	FINGER, GPU, SUS 301	1
2	BRACKET, TOP, GPU	6053B0346901	BRACKET, TOP, GPU, SECC	1
1		6043B0048201	THERMAL MODULE, MXM2	1
ITEM	PART NAME	PART NO	DESCRIPTION	Q'TY

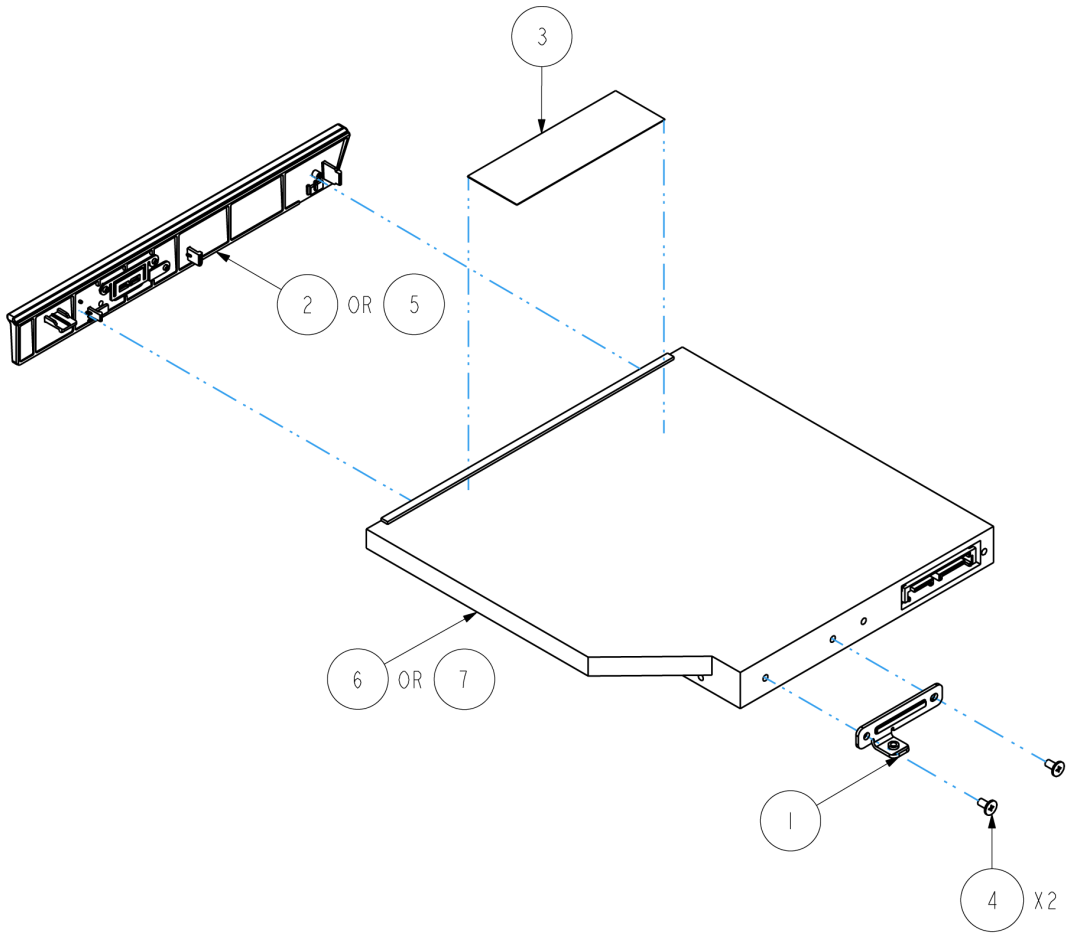

7		6029B0026701	DVD, SUPER MULTI, 5X, 8X, 6X, 8X, 8X, 24X, 24X, M2, 128X12.7X126.1mm, SLIM		1
6		6029B0026901	DVD, BD-COMBO, 8X, 16X, 10X, 24X, M2, 128X12.7X126.1mm, SLIM		1
5		1510B0468002	ASSEMBLY, BEZEL, ODD, OFFLINE		1
4	SCREW 120040W	6052A0036901	SCREW, 1, M2.0, 4mm, M, 4.5mm, 0.5mm, BNI, PATCH		2 2
3		6060B0221401	LABEL, BLANK, REEL, 60mm, 20mm		1 1
2		1510B0468001	ASSEMBLY, BEZEL, ODD, OFFLINE		1
1	CDROM BRACKET	6053B0031001	BRACKET, BOTTOM, ODD, SECC		1 1
ITEM	PART NAME	PART NO	DESCRIPTION		01 02

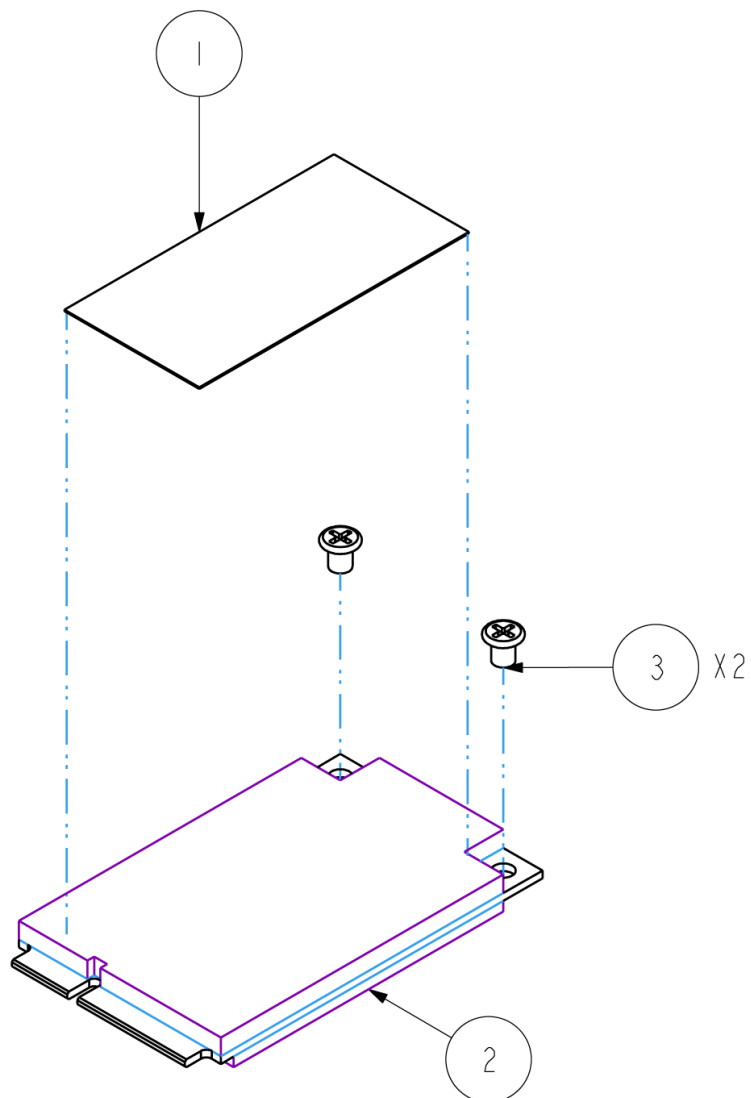

3	SCREW 125030M	6052A0034902	SCREW, 1, M2.5, 3mm, M, 4.5mm, 0.8mm, NI, PATCH	2
2		6042B0084401	MODULE, DVBT CARD, MINI CARD	1
1		6060B0238501	LABEL, BLANK, REEL, 40mm, 20mm	1
ITEM	PART NAME	PART NO	DESCRIPTION	Q'TY

Aspire 8930Q FRU List

Accessory

Category	Part Name and Description	Acer Part No.
	REMOTE CONTROLLER FOMOSA21 RC804V-B EU	RT.22700.008
	REMOTE CONTROLLER FOMOSA21 RC804V-B TC	RT.22700.009
	REMOTE CONTROLLER FOMOSA21 RC804V-B SC	RT.22700.010
	REMOTE CONTROLLER FOMOSA21 RC804V-B EN	RT.22700.011
	WISTRON ACER XPRESS CARD PHONE KIT REV 2.0	LC.VIP00.014
	EXTERNAL ANTENNA SET	25.AAMVN.004

Adapter

Category	Part Name and Description	Acer Part No.
	ADAPTER 90W 3PINS DELTA ADP-90SB BBEA 1.7X5.5X11 LF LEVEL4	AP.09001.013
	ADAPTER 90W LITE-ON PA-1900-24AR BLUE 1.7X5.5X11 LF LEVEL4	AP.09003.011
	ADAPTER 90W HIPRO HPOL093B13P BLUE 1.7X5.5X11 LF LEVEL4	AP.0900A.001
	ADAPTER DELTA 120W 19V 1.7X5.5X11 BLACK ADP-120ZB BBW, FOR PB LF	AP.12001.007





Battery

Category	Part Name and Description	Acer Part No.
	BATTERY LI-ION 8CELL SANYO AS-2007B 4S2P 4800MAH	BT.00803.024
	BATTERY LI-ION 8CELL SONY AS-2007B 4S2P 4800MAH	BT.00804.020
	BATTERY LI-ION 8CELL PANASONIC AS-2007B 4S2P 4800MAH	BT.00805.011
	BATTERY LI-ION 8CELL SIMPLO AS-2007B 4S2P 4800MAH	BT.00807.015

Board



Category	Part Name and Description	Acer Part No.
	WIRELESS LAN BOARD 512AN_MMWG SHIRLEY PEAK 5100 MM#895361	KI.SPM01.003
	WIRELESS LAN BOARD 533AN_MMWG SHIRLEY PEAK MM#895362	KI.SPM01.001

Category	Part Name and Description	Acer Part No.
	BLUETOOTH BOARD FOXCONN BCM2045 V2 T60H928.11	BT.21100.005
	MODEM BOARD MDC 1.5 FOXCONN T60M951.36 (AGERE 1.5_3.3V) AUSTRALIA APPROVED	FX.22500.023
	TOUCHPAD SYNAPTICS TM-00372-012	56.APQ0N.001
	POWER BUTTON BOARD	55.ASY0N.002
	HOTKEY BOARD	55.AP50N.001
	TOUCHPAD BUTTON BOARD	55.ASY0N.001
	I/O BOARD	55.ASY0N.003
	USB BOARD W/O TV CABLE	55.AP50N.005
	LED BOARD RIGHT	55.AP50N.006
	LED BOARD LEFT	55.AP50N.007
	FINGER PRINT BOARD	55.APQ0N.001

Category	Part Name and Description	Acer Part No.
	MEDIA BOARD MODULE	55.APQ0N.005
	USB BOARD WITH TV CABLE	55.AP30N.001
	TV TUNER MINI CARD AVERMEDIA DVB-T A309 REV 1.0	TU.23100.014
	TV TUNER MINI CARD AVERMEDIA DVB-T A310 REV 1.0	TU.23100.010
	FLASH MODULE 4GB INTEL NVCPEMWR004G2 LF	KF.4GB0N.002
	FLASH MODULE 2GB INTEL NVCPEMWR002G2 LF	KF.2GB0N.002
	MSI VGA Card nVidia NB9P-GS GDDRIII 512M 800MHz 32*32 MXM II w/ HDCP w/ Intersil PowerIC w/DP support Ver. A3	VG.9PG06.006
	Yuan VGA Card nVidia NB9P-GS GDDRIII 512M 800MHz 32*32 MXM II w/ HDCP w/ MPS PowerIC w/DP support Ver. A3	VG.9PG0Y.005
	MSI VGA Card nVidia 9EGEH GDDRIII 512M 800MHz 32*32 MXM III w/ HDCP	VG.9EG06.001
	YUAN VGA CARD NVIDIA NB9P-GS DDRII 1024M 400MHZ 64*16 MXM II W/ HDCP W/ MPS POWERIC	VG.9PG0Y.007

Cable

Category	Part Name and Description	Acer Part No.
	POWER CORD 3PIN USA	27.AAMVN.001
	POWER CORD 3PIN EUR	27.AAMVN.002
	POWER CORD 3PIN SOUTH AFRICA	27.AAMVN.008
	POWER CORD 3PIN DENMARK	27.AAMVN.010
	POWER CORD ISRAEL	27.AAMVN.011
	POWER CORD 3PIN ITALIAN	27.AAMVN.009
	POWER CORD 3PIN UK	27.AAMVN.004
	POWER CORD 3PIN SWISS	27.AAMVN.006
	POWER CORD AUSTRALIA W/LABEL	27.AAMVN.003
	POWER CORD 3PIN CHINA	27.AAMVN.005
	POWER CORD SOUTH AFRICA (AIL)	27.AAMVN.007
	POWER CORD 3PIN USA	27.AAMVN.001
	POWER CORD 3PIN TAIWAN	27.APQ0N.001
	POWER CORD 2PIN JAPAN	27.APQ0N.002
POWER CORD 3PIN ARGENTINA	27.TNX0N.001	

Category	Part Name and Description	Acer Part No.
	HOTKEY BOARD CABLE	50.AP50N.001
	POWER BUTTON BOARD CABLE	50.AP50N.002
	TOUCH BUTTON BOARD CABLE	50.ASY0N.001
	MEDIA BOARD CABLE	50.AP50N.004
	USB BOARD CABLE	50.ASY0N.002
	TOUCHPAD CABLE	50.AP50N.006
	DC-IN CABLE	50.AP50N.007
	DC-IN CABLE 120W	50.AFC0N.001
	BLUETOOTH BOARD CABLE	50.AP50N.008
	MODEM CABLE	50.AP50N.009
	MODEM CABLE WITH RJ11	50.AP50N.010
	FINGER PRINT BOARD CABLE	50.APQ0N.001

Category	Part Name and Description	Acer Part No.
	LCD/CAMERA CABLE 18.4" WUXGA/WXGA+	50.AP50N.011
	LCD/CAMERA CABLE 18.4" WUXGA/WXGA+	50.AP50N.011
	LCD/CAMERA CABLE 18.4" WXGA+	50.AP50N.012

Camra

Category	Part Name and Description	Acer Part No.
	CAMERA 0.3M SUYIN	57.APQ0N.001
	CAMERA 0.3M BISON BN30V407-010	57.ASY0N.001
	CAMERA 1.0M SUYIN CN1014-S36B-OV01	57.ASY0N.002

CASE/COVER/BRACKET ASSEMBLY

Category	Part Name and Description	Acer Part No.
	TOUCHPAD BRACKET	33.ASY0N.001
	UNILOAD COVER	42.AP50N.002
	UNILOAD COVER FOR 2ND HDD WITH 12.5MM	42.ASY0N.002
	MINI DUMMY CARD	42.AP50N.003
	SD DUMMY CARD	42.APQ0N.009
	LOWER CASE WITH TV PORT	60.AT20N.001
	LOWER CASE W/O TV PORT	60.ASY0N.001
	UPPER CASE WITH FINGERPRINT HOLE	60.ASY0N.002
	MIDDLE COVER	42.ASY0N.001

Category	Part Name and Description	Acer Part No.
	SUPER-MULTI BEZEL	42.APQ0N.004
	BD COMBO BEZEL	42.APQ0N.005
	OPTICAL BRACKET	33.AAMVN.002
	VGA BRACKET BOTTOM	33.AP70N.001
	VGA BRACKET TOP	33.APQ0N.003
	VGA BRACKET BOTTOM	33.AKE0N.005
	LCD COVER 18.4"	60.AP50N.005
	LCD BEZEL 18.4"	60.ASY0N.003
	LCD BRACKET RIGHT	33.AP50N.001
	LCD BRACKET LEFT	33.AP50N.002
	HINGE COVER ASSEMBLY LEFT	42.APQ0N.007
	HINGE COVER ASSEMBLY RIGHT	42.APQ0N.006
	KENSINGTON BRACKET	33.APQ0N.006

Category	Part Name and Description	Acer Part No.
	HALF MINI-CARD BRACKET	33.TQP0N.002

CPU/PROCESSOR

Category	Part Name and Description	Acer Part No.
	CPU INTEL CORE2DUAL P7350 PGA 2.0G 3M 1066 25W	KC.73501.DPP
	CPU INTEL CORE2DUAL P8400 PGA 2.26G 3M 1066 25W	KC.84001.DPP
	CPU INTEL CORE2DUAL P8600 PGA 2.4G 1066 25W 3M	KC.86001.DPP
	CPU INTEL CORE2DUAL P9500 PGA 2.53G 6M 1066 25W	KC.95001.DPP
	CPU INTEL CORE2DUAL T9400 PGA 2.53G 6M 1066 35W	KC.94001.DTP
	CPU INTEL CORE2DUAL T9600 PGA 2.8G 6M 1066 35W	KC.96001.DTP
	CPU INTEL CORE2QUAD Q9000 PGA 2.0G 6M 1066 45W	KC.90001.QQP

DVD RW DRIVE

Category	Part Name and Description	Acer Part No.
	ODD SONY BD COMBO 12.7MM TRAY DL 2X BC-5500S LF W/O BEZEL SATA	KO.0020E.002
	ODD PIONEER SUPER-MULTI DRIVE 12.7MM TRAY DL 8X DVR-TD08RS LF W/ O BEZEL SATA	KU.00805.044
	ODD SONY SUPER-MULTI DRIVE 12.7MM TRAY DL 8X AD-7580S LF W/O BEZEL SATA	KU.0080E.017
	ODD PLDS SUPER-MULTI DRIVE 12.7MM TRAY DL 8X DS-8A2S LF W/O BEZEL SATA	KU.0080F.001



FAN



Category	Part Name and Description	Acer Part No.
	FAN	23.AP50N.001

HDD/HARD DISK DRIVER

Category	Part Name and Description	Acer Part No.
	HDD 120GB SATA 5400RPM SEAGATE ST9120817AS CORSAIR LF F/W:3.AAA	KH.12001.032
	HDD 120GB 5400RPM SATA TOSHIBA MK1252GSX LF F/W:LV010J	KH.12004.008
	HDD 120GB 5400RPM SATA HGST HTS543212L9A300 LF F/W:C40C	KH.12007.016
	HDD 120GB 5400RPM SATA WD WD1200BEVS-22UST0 ML125 LF F/W:01.01A01	KH.12008.019
	HDD 160GB 5400RPM SATA SEAGATE ST9160310AS CORSAIR LF F/W:30303	KH.16001.034
	HDD 160GB 5400RPM SATA TOSHIBA MK1652GSX LF F/W:LV010J	KH.16004.003
	HDD 160GB 5400RPM SATA HGST HTS543216L9A300 LF F/W:C40C	KH.16007.019
	HDD 160GB 5400RPM SATA WD WD1600BEVT-22ZCT0 ML160 LF F/W:11.01A11	KH.16008.022
	HDD 250GB 5400RPM SATA SEAGATE ST9250827AS CORSAIR LF F/W:3.AAA	KH.25001.011
	HDD 250GB 5400RPM SATA TOSHIBA MK2552GSX LF F/W:LV010J	KH.25004.002
	HDD 250GB 5400RPM SATA HGST HTS543225L9A300 LF F/W:C40C	KH.25007.013
	HDD 250GB 5400RPM SATA WD WD2500BEVS-22UST0 ML125 LFF/W:01.01A01	KH.25008.018
	HDD 320GB 5400RPM SATA SEAGATE ST9320320AS LF F/W:0303	KH.32001.008
	HDD 320GB 5400RPM SATA SEAGATE ST9320320AS LF F/W:0303	KH.32004.001
	HDD 320GB 5400RPM SATA TOSHIBA MK3252GSX LF F/W:LV010J	KH.32007.004
	HDD 320GB 5400RPM SATA WD WD3200BEVT-22ZCT0 ML160 LF F/W:11.01A11	KH.32008.013
	HDD500GB 5400RPM SATA HGST HTS545050KTA300 LF F/W:C60G	KH.50007.007

HEATSINK

Category	Part Name and Description	Acer Part No.
	VGA HEATSINK	60.AP70N.001
	VGA HEATSINK	60.AP50N.006

Category	Part Name and Description	Acer Part No.
	VGA HEATSINK FINGER	33.APQ0N.002
	CPU HEATSINK	60.AP50N.003
	CPU HEATSINK FINGER	33.AP50N.003

INVERTER

Category	Part Name and Description	Acer Part No.
	INVERTER BOARD TDK-TBD489NR	19.AP50N.001
	INVERTER BOARD TDK-TBD489NR	19.AP50N.001

KEYBOARD



Category	Part Name and Description	Acer Part No.
	KEYBOARD 17_18KB-FV1 88KS BLACK US INTERNATIONAL (GLOSSY)	KB.INT00.297
	KEYBOARD 17_18KB-FV1 88KS BLACK US INTERNATIONAL HEBREW (GLOSSY)	KB.INT00.298
	KEYBOARD 17_18KB-FV1 89KS BLACK UK (GLOSSY)	KB.INT00.299
	KEYBOARD 17_18KB-FV1 89KS BLACK TURKISH (GLOSSY)	KB.INT00.300
	KEYBOARD 17_18KB-FV1 88KS BLACK THAILAND (GLOSSY)	KB.INT00.301
	KEYBOARD 17_18KB-FV1 89KS BLACK SWISS/G (GLOSSY)	KB.INT00.302
	KEYBOARD 17_18KB-FV1 89KS BLACK SWEDISH (GLOSSY)	KB.INT00.303
	KEYBOARD 17_18KB-FV1 89KS BLACK SPANISH (GLOSSY)	KB.INT00.304
	KEYBOARD 17_18KB-FV1 89KS BLACK SLOVAK (GLOSSY)	KB.INT00.305
	KEYBOARD 17_18KB-FV1 89KS BLACK SLO/CRO (GLOSSY)	KB.INT00.306
	KEYBOARD 17_18KB-FV1 88KS BLACK RUSSIAN (GLOSSY)	KB.INT00.307
	KEYBOARD 17_18KB-FV1 89KS BLACK PORTUGUESE (GLOSSY)	KB.INT00.308
	KEYBOARD 17_18KB-FV1 89KS BLACK POLISH (GLOSSY)	KB.INT00.309

Category	Part Name and Description	Acer Part No.
	KEYBOARD 17_18KB-FV1 89KS BLACK NORWEGIAN (GLOSSY)	KB.INT00.310
	KEYBOARD 17_18KB-FV1 89KS BLACK LUXEMBOURGISH (GLOSSY)	KB.INT00.311
	KEYBOARD 17_18KB-FV1 88KS BLACK KOREAN (GLOSSY)	KB.INT00.312
	KEYBOARD 17_18KB-FV1 88KS BLACK JAPANESE (GLOSSY)	KB.INT00.313
	KEYBOARD 17_18KB-FV1 89KS BLACK ITALIAN (GLOSSY)	KB.INT00.314
	KEYBOARD 17_18KB-FV1 88KS BLACK ISRAEL (GLOSSY)	KB.INT00.315
	KEYBOARD 17_18KB-FV1 89KS BLACK IRISH (GLOSSY)	KB.INT00.316
	KEYBOARD 17_18KB-FV1 89KS BLACK HUNGARIAN (GLOSSY)	KB.INT00.317
	KEYBOARD 17_18KB-FV1 88KS BLACK GREEK (GLOSSY)	KB.INT00.318
	KEYBOARD 17_18KB-FV1 89KS BLACK GERMAN (GLOSSY)	KB.INT00.319
	KEYBOARD 17_18KB-FV1 89KS BLACK FRENCH (GLOSSY)	KB.INT00.320
	KEYBOARD 17_18KB-FV1 89KS BLACK FINNISH (GLOSSY)	KB.INT00.321
	KEYBOARD 17_18KB-FV1 89KS BLACK DUTCH (GLOSSY)	KB.INT00.322
	KEYBOARD 17_18KB-FV1 89KS BLACK DANISH (GLOSSY)	KB.INT00.323
	KEYBOARD 17_18KB-FV1 89KS BLACK CZECH (GLOSSY)	KB.INT00.324
	KEYBOARD 17_18KB-FV1 88KS BLACK TRADITIONAL CHINESE (GLOSSY)	KB.INT00.325
	KEYBOARD 17_18KB-FV1 89KS BLACK CANADIAN FRENCH (GLOSSY)	KB.INT00.326
	KEYBOARD 17_18KB-FV1 89KS BLACK BRAZILIAN PORTUGUESE (GLOSSY)	KB.INT00.327
	KEYBOARD 17_18KB-FV1 89KS BLACK BELGIUM (GLOSSY)	KB.INT00.328
	KEYBOARD 17_18KB-FV1 88KS BLACK ARABIC/ENGLISH (GLOSSY)	KB.INT00.329
	KEYBOARD 17_18KB-FV1 89KS BLACK ARABIC/FRENCH (GLOSSY)	KB.INT00.330
	KEYBOARD 17_18KB-FV1 89KS BLACK NORDIC (GLOSSY)	KB.INT00.331
	KEYBOARD 17_18KB-FV1 89KS BLACK ENGLISH/CANADIAN FRENCH (GLOSSY)	KB.INT00.332

LCM

Category	Part Name and Description	Acer Part No.
	LCD MODULE 18.4" WUXGA GLARE W/ ANTENNA & CCD 0.3M	6M.AP50N.002
	LCD MODULE 18.4" WXGA+ GLARE W/ ANTENNA & CCD 0.3M	6M.AP50N.001
	LCD 18.4" WXGA+ SAMSUNG LTN184KT01-A01 GLARE LF 220NIT 8MS 800:1	LK.18406.002

MIAN BOARD





Category	Part Name and Description	Acer Part No.
	MAINBOARD AS8930Q INTEL PM45 ICH9 LF	MB.ASZ0B.001
	MAINBOARD TETON_2.5 INTEL PM45 ICH9 LF QC DISCRETE	MB.ASZ0B.004

MEMORY

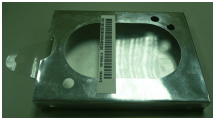
Category	Part Name and Description	Acer Part No.
	SO-DIMM 1GB DDRIII1066 MICRON MT8JSF12864HY-1G1D1 LF	KN.1GB04.003
	SO-DIMM 1GB DDRIII1066 ELPIDA EBJ11UE6BAU0-AE-E LF	KN.1GB09.009
	SO-DIMM 1GB DDRIII1066 SAMSUNG M471B2874DZ1-CF8 LF	KN.1GB0B.019
	SO-DIMM 1GB DDRIII1066 HYNIX HMT112S6AFP6C-G7N0 LF	KN.1GB0G.019
	SO-DIMM 2GB DDRIII1066 MICRON MT16JSF25664HY-1G1D1 LF	KN.2GB04.004
	SO-DIMM 2GB DDRIII1066 ELPIDA EBJ21UE8BAU0-AE-E LF 128*8 0.07um	KN.2GB09.002
	SO-DIMM 2GB DDRIII1066 SAMSUNG M471B5673DZ1-CF8 LF	KN.2GB0B.005
	SO-DIMM 2GB DDRIII1066 HYNIX HMT125S6AFP8C-G7N0 LF	KN.2GB0G.009

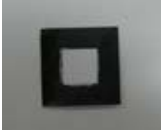
MISCELLANEOUS



Category	Part Name and Description	Acer Part No.
	HDD INSULATOR	47.ASY0N.001
	HDD INSULATOR FOR 2ND HDD WITH 12.5MM	47.ASY0N.002

Category	Part Name and Description	Acer Part No.
	VGA BOARD INSULATOR	47.AKE0N.002
	LCD CHUSION	47.APQ0N.001
	ANTENNA LEFT	50.ASY0N.003
	ANTENNA RIGHT	50.ASY0N.004
	MICROPHONE	23.ASY0N.001
	LCD RUBBER	47.ASY0N.003

SCREW

Category	Part Name and Description	Acer Part No.
	SCREW I M2 6MM M 4.5MM 0.8MM PHIL BK PATCH	86.APQ0N.004
	SCREW M2.5X0.45	86.APQ0N.001
	SCREW I M2.5 3MM M 4.5MM 0.8MM NI PATCH	86.AP50N.001
	SCREW BNI PAT	86.TLT0N.002
	SCREW PAN M2*0.4 6.0MM MACH 3.0MM 0.7MM CROSS NI	86.AP50N.002
	SCREW	86.TCXVN.006
	SCREW	86.AAMVN.001

SPEAKER

Category	Part Name and Description	Acer Part No.
	SPEAKER SET W/ SUB-WOOFER	23.AP50N.002
	SPEAKER SET (FRONT)	23.AP50N.003

